

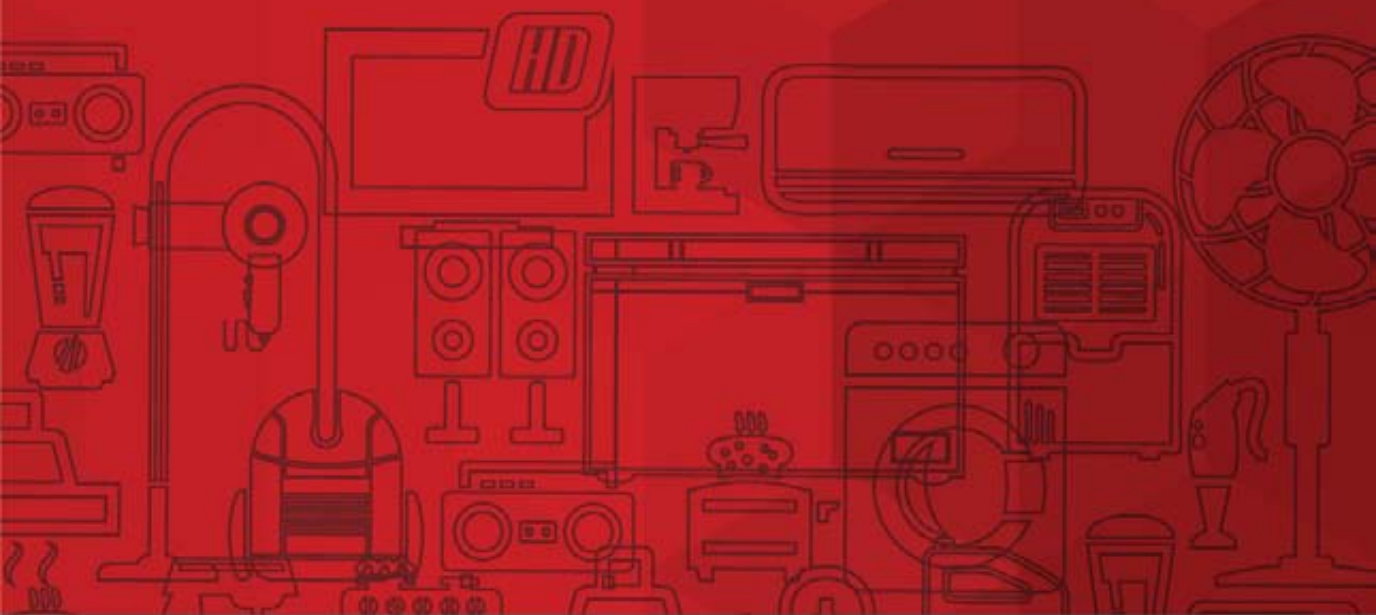

2018/19



• Audio • Visual • Home Appliances • Air Conditioner

PROFILE Of EXCELLENCE



1965 Establishment of Keat Radio & Electrical Co. in Balik Pulau, Penang by founder Dato' Seri Chew Weng Khak.



1974 1st Keat Radio & Electrical Co. branch was set up in line with its business expansion.

1976 Ventured into import, export and distribution of Electrical Home Appliances (EHA).

1977 Incorporation of Keat Radio Sdn. Bhd. as a private limited company.

1982 Pensonic Sales & Service Sdn. Bhd. was established to support import of audio and visual products under the brand "Pensonic", symbolising the 'Sound of Penang'.

1984 Registration of Pensonic trademark in Malaysia and eventual registration in over 20 countries.

1992 Expanded operations by opening a new manufacturing plant at Autocity, Juru.



1994 Incorporation of Pensonic Holdings Berhad.

1995 Successful listing on the Second Board of Bursa Malaysia.

1996 Moved to a more spacious office building and manufacturing plant to accommodate the increasing product demands of the Pensonic brand.



1999 Accorded the ISO 9002 accreditation.

2002

- Upgraded to ISO 9001 - 2000 accreditation.
- Pensonic Table Fan PF-42 won the 2002 'Energy Efficiency & Best Price Fan from Tenaga Nasional Berhad and Ministry of Energy, Communications and Multimedia.
- Involvement in Own Brand Manufacturing (OBM) and Own Design Manufacturing (ODM). Under its multi-brand business model, it owns **LEBENSSTIL KOLLEKTION** of Germany and holds the sole-distributorship in Malaysia for **PRINCESS** of Holland.
- The first Malaysian brand to be awarded the Brand Promotion Grant (for export market) and logo "MADE IN MALAYSIA FOR THE WORLD".

2003

- Pensonic is the only Electrical Home Appliances brand selected by the Malaysia External Trade Development Corporation (MATRADE) as one of the 20 leading and most prominent brands in Malaysia for the SHOWCASE MALAYSIA 2003 trade exhibition, held in conjunction with the 13th Non-Aligned Movement (NAM) Summit.

2004

- Awarded the NATIONAL CREATIVITY & INNOVATION AWARD by the Malaysia Design Technology Centre for outstanding brand building.



- Pensonic Blender PB-501 was recognised as the Malaysia Good Design Mark by the Malaysia Design Council.

2005

- Launch of Pensonic's new logo and '12 Pensonic Friends' campaign.



PROFILE Of EXCELLENCE

2006

- Launch of 'Pensonic Friends Season 2' campaign.
- Acquisition of Amtek Marketing Services Sdn. Bhd. and Amtek Marketing Services Pte Ltd which owns **CORNELL** of USA and obtained the sole-distributorship in Malaysia for internationally-acclaimed brands like **GE APPLIANCES** of USA and **MORPHY RICHARDS** of the UK.

2007

- Awarded the Brand Excellence Award by Ministry of International Trade and Industry.



- Launch of 'Pensonic Friends Season 3' campaign.
- Pensonic launched the new '25 Friends of Pensonic' campaign featuring 25 successful Malaysian icons to celebrate Pensonic's 25th anniversary.



2008

- Pensonic established its business presence in 27 countries worldwide.
- Recipient of **Brand Excellence Award** by the Ministry of International Trade and Industry.
- Launch of "Pensonic, Your Friend, Your Enjoyment" campaign.



2009

- Pensonic's innovative, humour infused **BOLD FAN** was voted **The Best Electronic Goods TVCS 2008** by Marketing Magazine. This Hokkien TV Commercial hit over **100,000** views within 2 days after it was posted on Pensonic YouTube channel.



2010

- Recipient of **Brand Excellence Award** by the Ministry of International Trade and Industry.
- Received the **Putra Brand Awards 2010**.
- Participated in the **NKEA** labs organised by **PEMANDU** to plan out the National Economic Transformation Program.



2011

- **Putra Brand Awards** Putra Brand Awards - 'Special Mention' Award in Personal Household & Outdoor Appliances.
- **Best Brand** In Consumer Electrical Home Appliances by The Brand Laureate Awards.



- **Honorary Award** by Young Entrepreneurs' Association of Malaysia (PUMM).
- **Brand Excellence Award (Merchandise)** Industry Excellence Award by MITI

- Announcement by the Prime Minister that Pensonic will spearhead a manufacturing hub and international distribution network of Electrical Home Appliances (EHA) as one of the fifteen Entry Point projects in E&E under the Country's Economic Transformation Program.



- '5-Star' Energy Efficiency Rating by Suruhanjaya Tenaga Malaysia.
- Became sole-distributor in Malaysia for Italian Coffee Machine Manufacturer Gaggia.

PROFILE Of EXCELLENCE

2012

The Most Promising Brand of the Year
by Putra Brand Awards.



Industry Excellence Award

Certificate of Excellence by Ministry of International Trade and Industry.



Penonic's 30th Anniversary Celebration at Mid Valley Megamall.

2014

• Participated in Ministry of International Trade and Industry 'Anugerah Kecemerlangan Industri'.



• Launch of Season 1 "Raya-Merdeka Bring Chef Home" Campaign and Chef's Like product series. Chef's Like product series are Dato' Chef Haji Ismail's favourite line of home products.

2015

• Penonic's founder, Y.Bhg Dato' Seri Chew Weng Khak, was the first recipient of the '2015 Putra Brand Personality of the Year Award' by Putra Brand Awards.



• Penonic's new Head Office (Global Operations & Innovation Centre) begins operations.



• Launch of Coffee Table Book "Braving the Limitless: The Story of the Man Behind Penonic, Chew Weng Khak" at Penonic's New Head Office Grand Opening Celebration Dinner.

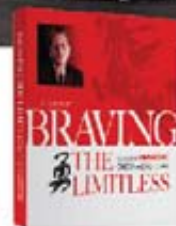

• Built and manufactured innovative mobile phone accessories. The smart power bank 'Fonebud Essential Plus' and 'Fonebud' brand was launched in August 2015.

2016

• Penonic Holdings Berhad awarded Malaysia **Good Design Mark 2015** for its latest innovative product, the **Fonebud Essential Plus**.



2017

• Group Chief Executive Officer **Dixon Chew** received the Dynamic Personage award for **Penonic Holdings Berhad** at the **McMillan Woods Global Awards Night 2017**. He received this award for his innovative thinking and role in helping to build a leading local home appliances brand. According to Euro Monitor's 2016 Report, Penonic is reigning as the third top selling brand in Malaysia among global brands.



• **Penonic Chef's Like Campaign Season 4 Live Cooking Tour 2017**, held due to enthusiastic dealers' popular demand, was hosted by Penonic Friend Dato' Chef Haji Ismail. The Live Cooking Tour was a huge success, and covered **12 dealer locations** across the nation from April to July 2017.



• Dato' Chef Haji Ismail's famous TV3 Cooking Show, "**Chef Mail Masak Bersama Penonic**" 2017 is now in its 3rd Season. This show has a steady increase in viewership every year and this year, the viewership has reached more than **7 million** viewers.

INDEX

01

Profile of Excellence

05

Kitchen Appliances

blender, nutri de blender, juice extractor, kettle, jug kettle, thermo flask, thermo pot, water filter, water dispenser, coffee maker, pure water system, steamboat, induction cooker, table grill, oven, microwave oven, hand mixer, stand mixer, toaster, sandwich toaster, oven toaster, multi cooker, gas rice cooker, slow cooker, rice cooker, built-in hob, infrared gas cooker, single burner gas cooker, double burner gas cooker, commercial stove, portable gas cooker, steamer, yogurt maker, food processor, personal blender

Chef's Like (23-24)

blender, thermo flask, stand mixer, oven, microwave oven, induction cooker, multi cooker, rice cooker, bread maker, air fryer, steamer, convection oven

Chef Room (25-26)

built-in cooker hood, built-in gas hob, built-in oven, built-in microwave oven

Installation Specification Diagrams (27-28)

built-in cooker hood, built-in gas hob, built-in oven, built-in microwave oven

Longevity Cookware (29-30)

purple clay multi-purpose rice cooker, purple clay rice cooker, ceramic double boiler, ceramic steamer

31

Home Comfort

air cooler, table fan, stand fan, industrial fan, wall fan, box fan, mist fan, tower fan, ceiling fan, water heater, insect killer, vacuum cleaner, portable air conditioner, air conditioner, exhaust fan, multipurpose light, circulation fan

Bold Fan (34)

stand fan, table fan

AQUA de Splash (38)

water heater

Fighter Series Specifications (39)

air conditioner

41

Audio Visual

LED TV, CD player, portable radio, DVD player

44

Accessories

water filter, vacuum bag, gas regulator, blender, cartridge, water heater, fan blade, ducting cap

45

Refrigeration

refrigerator, freezer

47

Laundry Helpmate

washing machine, steam iron, spray iron, dry iron

51

Amberchia Mesmerized by Pensonic

hair dryer, 2 in 1 curler & straightener

53

Classic Series

sandwich toaster, juicer, bread maker, jug kettle, food steamer, table fan, stand fan



HAND BLENDER

PB-7511

700ml Beaker

500ml Food Processor Bowl



Whisk

Whisk, Whip, Blend & Chop

A hand held, immersion blender with a robust, 500W motor that's such a pleasure to use. Single touch speed button makes pureeing, blending, whisking and chopping a breeze.

Easily cleaned stainless steel shaft with slim, ergonomic grip handle reaches easily into pitchers, bowls and pots.



BLENDS SMOOTHIES



CHOPS VEGETABLES



CHOPS DRIED FRUITS & NUTS



MASHES POTATOES



WHIPS CREAM



BLENDS SOUPS

Nutri de Blender



PNB-1

- Jug 2.0L • 38,000 rpm • 3 hp • 1680W
- Japanese Stainless Steel Blade
- Powerful Motor • LCD Display
- PCB Function Control with 6 Functions & 8 Modes
- Suitable for Vegetables, Soy Milk, Sauces, Smoothies, Cream Soups, Nuts



Vegetables



Soy Milk



Sauces



Smoothies



Soups



Nuts

► **Easy to use**

Smart One Touch Pre-set functional buttons to process vegetables, soy milk, sauces, smoothies, soups & nuts, especially convenient for baby food processing.

► **Patented heavy-duty stainless steel blade from Japan**

Best performance to ensure freshness of food.

► **High Nutrition**

With high speed motor of 38,000 rpm, all phytonutrients of fruits and vegetables can be well blended and fully absorbed by our bodies.

► **Patented and high quality polycarbonate jug**

It is able to withstand high temperature, easy to use, easy to clean and hygienic.

► **Dual safety protection motor**

Equipped with an upgraded design that allows overheat and displacement shut off.



PNB-2

- Jug 1.5L • 300W
- Eight-cutter Blades with Grinder for Finer Juice Processing
- Convenient Juice Dispensing with Faucet Spout Feature
- Circular Grinding Provides more Delicate and Exquisite Juice Enjoyment
- Maximises Nutrition and Taste in Juices of Fruits, Vegetables, Grains and Grasses
- Blends Fruits, Vegetables, Sauces, Smoothies, Nuts, Grains, etc.



As featured in
WOWSHOP



Able to withstand temperature up to 109 degree Celsius, prevent your beverages from being contaminated.



Extremely low noise and low vibration, but with even greater power.



Your blended fruits, nuts or vegetables will grind and circulate around the jug to provide you more delicate and exquisite juice blending experience.



The perfectly blended juices are easily absorbed by your body.



fitmi

by Pensonic

Fresh Fruit Juice



Smoothies



Crush Ice



BLENDER



PB-426

- 1.25L • 350W
- 2-Speed with Pulse
- Stainless Steel Blade
- With Safety Lock
- Mill Attachment
- Jug Cover with Stopper Hole



PB-510

- 1.5L • 400W
- 2-Speed with Pulse
- Stainless Steel Blade
- Dual Safety Lock
- Mill Attachment
- Jug Cover with Stopper Hole



PB-3103

- 1.0L • 250W
- 1-Speed
- Stainless Steel Blade
- With Stirrer
- Dual Safety Lock
- Mill Attachment



PB-3206

- 1.0L • 250W
- 1-Speed
- Stainless Steel Blade
- With Stirrer
- Safety Switch
- Mill Attachment



PB-3203

- With Mill Attachment

PB-3203L

- Without Mill Attachment

- 1.0L • 250W
- 1-Speed
- Stainless Steel Blade
- With Stirrer
- Safety Switch



PB-3205

- Without Extra Jug

PB-3205DJ

- With Extra Jug 1.0L

PB-3205L

- Without Mill Attachment



PB-3301

- 1.0L • 250W
- 2-Speed with Pulse
- Stainless Steel Blade
- With Stirrer
- Safety Switch
- Mill Attachment

fitmi
by Panasonic

PERSONAL BLENDER

- 250W • 220 - 240V ~ 50/60Hz
- 2 X 600ml BPA-free Tritan Sports Bottle
- Stainless Steel Cutter Blades
- Safety Lock Protection
- Non-slip Grip Feet
- Leak-proof Travel Lid and Snap Hook
- Blends Fruits, Vegetables and Crushes Ice
- Ideal Choice for Travellers



PB-4003B



PB-4004V



PB-4005P



FOOD PROCESSOR



PB-5001

- 500W • 2-Speed with Pulse
- 1.8L Jug • 1.2L Food Processor Bowl
- Motor with Overheating Protection
- Double Safety Switch
- Multi-function: Blending / Chopping / Slicing / Grating / Emulsifying / Juicing
- Accessories: Slicing Blade, 2 Shredding Blades, Chopper, Kneading Blade, Emulsifying Disc, Citrus Juicer, Blender



Blender



Chopper



Citrus Juicer



Emulsifying Disc



Shredding Blade



Shredding Blade



Slicing Blade



Kneading Blade



PB-4000

- 800ml • 350W
- 1-Speed
- Stainless Steel Blades
- Multi-function: Blender / Grinder / Chopper / Juice Extractor



PB-7511

- 500W • 220 - 240V ~ 50/60Hz
- 2-Speed
- Slim Handle Design
- Ergonomic Grip
- Handles Pureeing, Blending, Whisking & Chopping with Ease
- Accessories: 500ml Food Processor bowl, 700ml Beaker, Whisk and Chopper

JUICE EXTRACTOR



PJ-37

- 400W
- 2-Speed
- Safety Switch
- With Fruit Tray
- With Juice & Pulp Container
- Double Safety Lock
- Stainless Steel Filter



PJ-57

- 300W
- 1-Speed
- Stainless Steel Filter
- Safety Switch



YOGURT MAKER

PYM-700

- 15W • Ready in 6 to 8 Hours
- Automatic Yogurt Maker
- Makes Seven 200ml Serving of Yogurt at Once
- Add Preferred Ingredients, Flavours and Sweetness



PJ-300

- 400W
- 2-Speed
- With juice and pulp container
- With transparent lid
- Anti-slip rubber feet
- Double safety lock
- Stainless Steel Filter & Blade



KETTLE / JUG KETTLE



PAK-25C

- 5.0L • 1850-2200W
- Auto Switch Off
- High Grade Polished Stainless Steel Body
- Boil-dry Protection



PAK-5000C

- 5.0L • 1850-2200W
- Auto Switch Off
- Cordless
- 360° Swivel Base
- High Grade Polished Stainless Steel Body
- Boil-dry Protection



PMK-1400

- 1.4L
- Cordless with 360° Swivel Base
- Cool-touch Body
- Boil-dry Protection
- Stainless Steel Heating Element
- Manual Keep Warm Function
- Water Level Gauge with Night Light
- Detachable Lid for Easy Cleaning



PAB-19

- 1.8L • 1850-2200W
- Auto Switch Off
- UK Strix Control
- Boil-dry Protection
- Illuminated On / Off Switch



PAB-110C

- 1.0L • 840-1000W
- Auto Switch Off
- Cordless
- UK Strix Control
- Illuminated On / Off Switch
- Extra Filter



PAB-170CS

- 1.7L • 1850-2200W
- Auto Switch Off
- Cordless
- UK Strix Control
- Illuminated On / Off Switch
- Stainless Steel Body
- Concealed Heating Element



PAB-171C

- 1.7L • 1850-2200W
- Auto Switch Off
- Cordless
- UK Strix Control
- Built-in Thermal Fuse
- Illuminated On / Off Switch
- Extra Filter



PAB-1704

- 1.7L • 1850-2200W
- Auto Switch Off
- Cordless
- Stainless Steel Heating Element
- Boil-dry & Overheat Protection



PAB-1705

- 1.7L • 1850-2200W
- Auto Switch Off
- Cordless
- Stainless Steel Heating Element
- Boil-dry & Overheat Protection

PAB-1706C

- 1.7L • 1850-2200W
- Auto Switch Off
- Cordless
- 360° Swivel Base
- Stainless Steel Heating Element
- Boil-dry & Overheat Protection
- Anti-slip Feet & Cord Storage
- Concealed Heating Element



PAB-1708CS

- 1.7L • 1830W
- Cool Touch • Cordless
- Keep Warm • 360° Swivel Base
- Auto Switch Off
- Seamless, Rounded Inner Tank
- Boil-dry & Overheat Protection
- Concealed Heating Element



PAB-1709CS

- 2.0L • 1850-2200W
- Cordless • 360° Swivel Base
- Auto Switch Off
- Boil-dry & Overheat Protection
- With Cord Storage
- Concealed Heating Element



Food grade, corrosion resistant stainless steel.



THERMO FLASK



PTF-30B

- 3.0L • 730W
- Manual Dispenser with Lock
- Auto Reboil / Keep Warm
- 360° Swivel Base
- Stainless Steel Inner Pot
- Lock / Unlock Safety Feature
- 3-way Dispenser
- Water Level Gauge



PTF-300I

- 3.0L • 750W
- Auto Reboil / Keep Warm
- 360° Swivel Base
- Water Level Gauge
- Stainless Steel Inner Pot
- 2-way Dispenser (Button / Cup)



PTF-500A

- 5.0L • 730W
- Auto Reboil / Keep Warm
- 360° Swivel Base
- Water Level Gauge
- Stainless Steel Inner Pot
- 2-way Dispenser (Button / Cup)



PTF-500E

- 5.0L • 750W
- Auto Reboil / Keep Warm
- 360° Swivel Base
- Stainless Steel Inner Pot
- Water Level Gauge
- 2-way Dispenser (Button / Cup)



PTF-500I

- 5.0L • 750W
- Auto Reboil / Keep Warm
- 360° Swivel Base
- Stainless Steel Inner Pot
- Water Level Gauge
- 2-way Dispenser (Button / Cup)



PTF-600A

- 6.0L • 730W
- Auto Reboil / Keep Warm
- 360° Swivel Base
- Water Level Gauge
- Stainless Steel Inner Pot
- 2-way Dispenser (Button / Cup)



PTF-5003

- 5.0L • 750W
- Auto Reboil / Keep Warm
- 360° Swivel Base
- Water Level Gauge
- Stainless Steel Inner Pot
- 2-way Dispenser (Button / Cup)



PTF-6000

- 6.0L • 730W
- Auto Reboil / Keep Warm
- 360° Swivel Base
- Stainless Steel Inner Pot
- Water Level Gauge
- 2-way Dispenser (Button / Cup)



WATER DISPENSER



PWD-200

- 750-890W
- Anti-dry Boil Protection
- Cool-touch Body
- Detachable Top Cover for Easy Cleaning
- Water Level Indicator with Night Light
- Auto Reboil & Keep Warm
- 24 Hours Standby Mode
- Stainless Steel Inner Pot
- Hot Water Capacity: 5L
- Warm Water Capacity: 2L



PWD-700

- 680W
- Stopcock Button
- Water Level Indicator
- Auto Boil & Reboil Function
- Keep Warm Function
- Easy-to-use Operation Button
- Hot Water Capacity: 5.4L
- Warm Water Capacity: 1.6L



Food grade, corrosion resistant stainless steel.



WATER FILTER

**PP-123**

- Double Filtration System
- CTO Carbon Block
- 100% Coconut Shell Activated Carbon
- Removes Chlorine, Organic Chemicals, Unpleasant Odour and Colour
- Polypropylene Filter Provides Effective Filtration & Eliminates Certain Organic Toxins & Metals

Cartridge: PP-123R1 / 123R2

**PMP-15**

- Container Capacity: 15L
- Filter Capacity: 48-71 Litres / day
- Type of Purification: Ceramic Filtration
- Dim (mm): 660(H) x 315(W) x 315(D)

Cartridge:
PMP-15R1 / 15R2 / 15R3

PURE WATER SYSTEM

**PFS-6**

- Removes & Reduces Dirt, Solids & Harmful Bacteria
- Mild Alkaline Water Helps to adjust pH Balance of Body Fluids
- Better Water Absorption & Enriches the Oxygen Content of Water
- Removal of Chlorine, Odour & Enhances the Water Quality
- Cartridge : PFS-6RG / 6R1 / 6R2 / 6R3 / 6R6

ECO THERMOPOT

**PET-4000L**

- 4.0L • Child-lock
- With Stop Button
- Variable Volume
- One Touch Auto Dispenser
- Full Cup Freshly-boiled Water within 45 secs
- Integrated Drip Tray
- Consistent & Smooth Water Delivery
- Stylish Blue Light Indicator

COFFEE MAKER

**PCM-1900**

- 800W • 1.2L (10 cups)
- On/Off Switch with Indicator Light
- Warming Plate
- Removable Filter
- Anti-drip Device
- Accessories: Measuring Spoon
- Translucent Water Tank with Level Indicator

**PCM-1901**

- 750W • 1.25L (10 cups)
- On/Off Switch with Indicator Light
- Warming Plate
- Removable Filter Holder
- Anti-drip Device
- Water Level Indicator
- Accessories: Measuring Spoon
- Translucent Water Tank with Level Indicator

MICROWAVE OVEN

PMW-280MD

- 28L
- Input Power: 1450W
- Output Power: 900W
- Input Power (Grill): 1100W
- With Lock Function & Defrost Setting
- Digital Joy Wheel Control
- Grill Function
- Mirror Design with Pull Handle Door
- 8 Auto-cook Programmes
- Cooking Timer: 0-95 Minutes
- Glass Turntable Diameter: 315mm

**PMW-202M**

- 20L
- Input Power: 1100 - 1150W
- Output Power: 650 - 700W
- Painted Cavity
- Manual Control
- Cooking End Signal
- 6 Microwave Power Levels (Including Defrost)
- Mirror Design with Pull Handle Door
- Cooking Timer: 0-35 Minutes
- Glass Turntable Diameter: 255mm



OVEN

PEO-1100

- 100L • 2700W
- Adjustable Temperature Control with Indicator Light
- Automatic Shut Off • Toast, Grill, Bake
- Combination of Heater & Function Selector for
 - Rotisserie / Convection / Rotisserie & Convection
 - Upper / Lower / Upper & Lower Heating
- Wire Rack, Baking Tray, Tray Handle, Crumb Tray, Rotisserie Fork & Rotisserie Fork Handle Provided
- Stainless Steel Body
- 60-minutes Timer Chime
- With Inner Light



PEO-2000

- 20L • 1380W
- 60 Minutes Timer with Automatic Shut Off & Chime
- Adjustable Temperature Control with Indicator Light
- Heater Selector for Upper, Lower or Both
- Tray, Tray Handle & Grid Iron Provided
- Toast, Grill & Bake



PEO-2001

- 20L • 1380W
- 60 Minutes Timer with Automatic Shut Off & Chime
- Adjustable Temperature Control
- Heater Selector for Upper, Lower or Both
- Tray, Tray Handle & Grid Iron Provided
- Toast, Grill & Bake



PEO-3500 / 4200

- 60 Minutes Timer with Automatic Shut Off & Chime
- Adjustable Temperature Control with Indicator Light
- Heater and Function Selector for
 - Upper and Lower Heating with Convection
 - Lower Heating with Convection
 - Upper and Lower Heating
 - Upper Heating with Rotisserie
 - Upper and Lower Heating with Convection and Rotisserie
- Tray, Tray Handle, Grid Iron, Rotisserie Fork and Crumb Tray Provided
- With Rotisserie & Convection Function
- With Stainless Steel Body
- With Inner Light



PEO-3500 PEO-4200

- 35L • 42L
- 1500W • 1800W

PEO-3501 / 4501

- 60 Minutes Timer with Automatic Shut Off & Chime
- Adjustable Temperature Control with Indicator Light
- Heater and Function Selector for
 - Upper and Lower Heating with Convection
 - Upper Heating with Convection
 - Upper and Lower Heating
 - Upper Heating with Rotisserie
 - Upper and Lower Heating with Convection and Rotisserie
- Tray, Tray Handle, Grid Iron & Rotisserie Fork Provided
- With Rotisserie & Convection Function
- Stainless Steel Body



PEO-3501 PEO-4501

- 35L • 45L
- 1600W • 2000W

AE-350N / 420N

- 60 Minutes Timer with Automatic Shut Off & Chime
- Adjustable Temperature Control with Indicator Light
- Heater and Function Selector for
 - Upper and Lower Heating with Convection
 - Lower Heating with Convection
 - Upper and Lower Heating
 - Upper Heating with Rotisserie
 - Upper and Lower Heating with Convection and Rotisserie
- Tray, Tray Handle, Grid Iron & Rotisserie Fork Provided
- With Rotisserie & Convection Function
- Stainless Steel Body



AE-350N AE-420N

- 35L • 42L
- 1500W • 1800W

AE-600N

- 60L • 2000W
- 60 Minutes Timer with Automatic Shut Off & Chime
- Adjustable Temperature Control with Indicator Light
- Heater and Function Selector for
 - Upper and Lower Heating with Convection
 - Lower Heating with Convection
 - Upper and Lower Heating
 - Upper Heating with Rotisserie
 - Upper and Lower Heating with Convection and Rotisserie
- Tray, Tray Handle, Grid Iron, Crumb Tray & Rotisserie Fork Provided.
- With Rotisserie & Convection Function
- With Inner Light
- Stainless Steel Body





PSB-131G

BBQ GRILL & HOT POT

Experience a Whole
New Level of Taste
& Flavour



Become a BBQ and Hot Pot Pro

Whether juicy meats, burgers or crispy vegetables, non-stick coating and die-cast plate cooks food to perfection, without sticky remnants to clean up later.



Portable, Convenient, Stylish

Convenient carry handle and detachable thermo-controller lets you enjoy BBQ and Hot Pot indoors or outdoors. Looks amazing on your table too!



No More Waiting!

Food cooks faster and is tastier with rapid cooking and even heating.

STEAMBOAT



PSB-1285

- 3.8L
- 1600W
- See-through Glass Lid
- Adjustable Temperature Control
- Short Heat-up Time
- Removable Stainless Steel Pot for Easy Cleaning & Storage



PSB-131G

- 2.5L • 1900W
- Dimension 370mm
- Detachable Thermo-controller
- Rapid & Even Heating
- Heat Insulation & Convenient Handle
- Non-stick Coating Die-cast Plate
- BBQ Grill & Hot Pot



PSB-130G

- 3.0L • 2100W
- 2-in-1 Steamboat and BBQ
- ▲ Steamboat - 1600W
- ▲ BBQ - 500W
- Steamboat and BBQ Can be Used at Same Time or Separately
- Heats Up Quickly and Evenly
- Removable Non Stick Pot for Easy Cleaning
- With Tempered Glass Lid

CERAMIC COOKER

PCC-2200D

- 2200W
- Knob and Touch Control
- Slim Body with Aluminum Alloy Base
- Power and Temperature Adjustable
- Boost Function
- Memory Function
- Portable with Handles
- Multi Cooking Menu: Boil, Stir fry, Soup, BBQ, Hot Pot
- Accessories: Grill Rack, BBQ Pan with Oil Collector



CERAMIC



GLASS



STAINLESS STEEL



CLAY POT



GRILL RACK



BBQ PAN WITH OIL COLLECTOR

INDUCTION COOKER



PIC-20

- 2000W
- LCD Display Control Panel
- Ceramic Glass Cook Top
- Child Lock
- Intelligent Micro-computer Control with Touch Sensor
- Cool-touch Cooking Surface
- With Stainless Steel Soup Pot
- 3 Preset Functions: Soup, Rice, Milk
- 4 Adjustable Functions: Stir Fry, Hot Pot / Steamboat, Keep Warm & Power



PIC-21

- 2000W
- LCD Display Control Panel
- Ceramic Glass Cook Top
- Intelligent Micro-computer Control with Touch Sensor
- Cool-touch Cooking Surface
- With Stainless Steel Soup Pot
- 3 Preset Functions: Sauté, Milk, Warm
- 4 Adjustable Functions: Deep Fry, Hot Pot / Steamboat, Soup & Rice

TABLE GRILL



PTG-101G

- 1500W - 1700W
- Large Cooking Surface
- Non-stick Coating Plate, Ribbed for Grilling and Flat Surface for Stir Frying
- Adjustable Temperature Control and Power On Indicator
- Detachable Cooking Plate with Serving Handles
- Detachable Drip Tray for Easy Cleaning
- With Clear Tempered Glass Lid

STEAMER



PSM-1600S

- 1350W • Tank: 4L, Steam Tray: 4L each
- Double Tier Steamer Baskets to Prepare a Variety of Dishes at the Same Time
- Stainless Steel, Multi-function Food Steamer for Steaming, Stewing and Boiling
- 60 Minute Timer with Auto Shut Off
- Boil-dry Protection
- Tempered Glass Lid for Easy Viewing of Cooking Progress



Food grade, corrosion resistant stainless steel.



YOU'RE THE BOSS

Set the power and adjust the temperature as you prefer for different types of food and cooking methods.

PERFECT FOR ANY POT

Heats up any pot quickly and evenly, whether stainless steel, glass, ceramic or clay pot.

JACK OF ALL TRADES

It boils, stir-fries, simmers soups, barbeques and works fantastic as a hot pot heater!

TRAVEL FRIENDLY COOKTOP

Portable, slim body with aluminium alloy base and easy carry handles makes it an ideal indoor or outdoor cooktop for a barbeque or hot pot.

PRECISION & POWER ON

YOUR COUNTERTOP



Perfect

for any type of cooking and pot



CERAMIC



GLASS



STAINLESS STEEL



CLAY POT



GRILL RACK



BBQ PAN WITH OIL COLLECTOR

STAND MIXER

**PM-600**

- 1000W • 5L
- Brushed Stainless Steel Bowl
- Powerful Motor with Low Noise Design
- Tilt Head for Easy Operation
- Transparent Splash Cover
- 6-speed for All Mixing Needs
 - Pulse Control
- Skid Resistant Feet

**PM-6001**

- 1000W • 5L
- Stainless Steel Mixing Bowl with Integrated Splash Guard
- Powerful 1000W Motor Handles Thick or Larger Loads of Mixing with Ease
- Tilt Head Allows Easy Access to Mixture and Attachments
- Safety Switch Settings for Safe Operation
- 8-speed Settings with Pulse Function
- Thermal Protection Prevents Overheating
- With Flat Beaters, Dough Hooks and Wire Whisk

**PM-215**

- 300W • 3.5L
- 5-Speed for All Mixing Needs
- Turbo Power
- Swivel Bowl for Even Mixing
- Light Weight for Easy Handling
- Positive Beater Lock
- Unique & Easily Removed Suction Feet for Stability
- With Beaters and Dough Hooks

HAND MIXER

PM-116 (B)**PM-116 (G)**

- 300W
- 5-Speed for Different Mixing Needs
- Turbo Powered
- Light Weight, Ergonomic Design for Easy Handling
- Push Button Beater Ejection
- With Beaters and Dough Hooks

PM-163

- 120W
- 5-Speed for All Mixing Needs
- Positive Beater Lock
- Light Weight for Comfort Handling
- With Beaters and Dough Hooks

TOASTER

**AK-3N**

- 2 Slices
- 700W
- Auto Pop-up
- Crumb Tray
- Browning Control Knob

**AK-4**

- 4 Slices
- 1200W
- Auto Pop-up
- Crumb Tray
- Browning Control Knob

**PT-928**

- 2 Slices • 680W - 820W
- Wide Slots (30mm)
- Browning Control Knob
- Removable Crumb Tray for Easy Cleaning
- Cancel Button
- Extra-lift, Auto Safety Shut Off and Auto-centering Tray

**PT-929**

- 2 Slices • 750W
- Wide Slots (30mm)
- Browning Control Knob
- Removable Crumb Tray for Easy Cleaning
- Cancel Button
- Extra-lift, Auto Safety Shut Off and Auto-centering Tray

SANDWICH TOASTER

**PST-960**

- 750W
- Durable Casing
- Non-stick Coating
- Cool-touch Housing
- With Indicator Light
- Stand Upright for Easy Storage

**PST-961**

- 700W
- Non-stick Coating
- Durable Casing
- Cool-touch Housing
- With Indicator Light
- Stands Upright for Easy Storage



FAST, WHOLESOME *and* FLAVOURFUL COOKING

DOUBLE
THE DISH,
DOUBLE
THE DELIGHT!

Shorten cooking time
by preparing two
different dishes
simultaneously with
the food grade,
stainless steel two
tier pots.

SUMPTUOUS
STEAMBOAT

Variable heat control
keeps soups at the
right temperature for
maximum taste and
enjoyment.



SAFE AND
CLEAN
COOKING

Tempered glass lid
allows easy viewing
of cooking progress
while boil dry
protection and
fireless cooking
makes this appliance
a safe and conveni-
ent cooking option.

PMC-1301

Food grade, corrosion
resistant stainless steel.

Food Grade
SUS 304

Largest Capacity Steam Tray



OVEN TOASTER

**POT-901**

- 11.5L
- 950W - 1150W
- 30 Minutes Timer with Automatic Shut Off & Chime
- Tray Provided
- Toast, Grill, Bake
- Removable Crumb Tray for Easy Cleaning

**POT-921**

- 9.0L
- 800W
- 60 Minutes Timer with Automatic Shut Off & Chime
- Tray Provided
- Toast, Grill, Bake
- Adjustable Temperature Control
- 2 High Efficiency Quartz Elements

GAS RICE COOKER

**PGR-888N**

- 1.1L • 60 Persons
- Auto Ignition System
- Fully Automatic • For LPG Use
- See-through Glass & Stainless Steel Lid

**PGR-899N**

- 1.4L • 80 Persons
- Auto Ignition System
- Fully Automatic • For LPG Use
- See-through Glass & Stainless Steel Lid

RICE COOKER

**PRC-100**

- 4.2L • 1600W
- 25 Persons
- Cook & Keep Warm Function
- Non-stick Inner Pot
- Cool Touch Housing
- Accessories: Rice Scoop, Measuring Cup

PRC-130

- 5.4L • 1950W
- 30 Persons

MULTI COOKER

**PMC-1201**

- 1.2L • 800W
- Two Adjustable Temperature Control Settings
- Seamless, Rounded Edges in Inner Tank, Simplifies Cleaning
- Cordless Kettle with 360° Swivel Base
- Boil Dry and Overheating Protection
- Concealed Heating Element
- Multifunction Kettle Boils Water, Steams Buns, Cooks Noodles and Eggs

PMC-1301

- 3.0L • 1600-1900W

PMC-1501

- 5.0L • 1800-2140W
- Easily Adjustable Temperature Control (Low, Medium, High)
- Removable SUS304 Food Grade Stainless Steel Inner Pot
- Double Tier Steamer Basket to Prepare a Variety of Dishes at the same time
- 1 Tier Removable Interior Base to Maximize Capacity
- Tempered Glass Lid for Easy Viewing of Cooking Progress
- Boil-dry Protection

Food Grade
SUS 304

**PMC-138**

- 3.8L • 1500-1780W

PMC-150

- 5.0L • 1650-1960W
- Adjustable Temperature Control
- Removable Non-stick Inner Pot
- With Tempered Glass Lid
- Steamboat, Deep Fry, Stew

**PMC-138S**

- 3.8L • 1200-1420W
- Removable Non-stick Inner Pot
- With Tempered Glass Lid & Steam Tray
- Steaming, Steaming, Stir Frying, Deep Frying



Food grade, corrosion
resistant stainless steel.



SLOW COOKER

**PSC-82**

- 0.6L • 65W
- Flowerly Casing
- With Indicator Light

**PSC-582**

- 4.5L • L-130W • H-260W
- Flowerly Casing
- With Indicator Light
- 3 Temperature Settings: Low / High / Auto

**PSC-101**

- 1L • 100-120W
- Flower Casing
- With Indicator Light
- 3 Temperature Settings: Low / High / Auto

**PSC-301**

- 3L • 215-255W
- Flower Casing
- With Indicator Light
- 3 Temperature Settings: Low / High / Auto

**PSC-501**

- 5L • 290-345W
- Flower Casing
- With Indicator Light
- 3 Temperature Settings: Low / High / Auto

RICE COOKER

**PSR-17L**

- 1.8L • 700W-832W
- 5-8 Persons
- Keep Warm Function
- Cool-touch Housing
- Non-stick Inner Pot
- With Dew Collector
- Detachable Power Cord
- Accessories: Steaming Tray, Rice Scoop, Measuring Cup

**PSR-17R**

- 1.8L • 700-832W
- 5-8 Persons
- Keep Warm Function
- Lid Cover with Tempered Glass
- Stainless Steel Inner Pot
- Cool-touch Housing
- Detachable Power Cord
- Accessories: Steam Tray, Rice Scoop, Measuring Cup

**PSR-18B**

- 1.8L • 700W
- 5-8 Persons
- Keep Warm Function
- Cool-touch Housing
- Non-stick Inner Pot
- With Dew Collector
- Detachable Power Cord
- Accessories: Steam Tray, Rice Scoop, Measuring Cup

**PSR-22C**

- 2.2L • 700W
- 9-12 Persons
- Keep Warm Function
- Cool-touch Housing
- Non-stick Inner Pot
- With Dew Collector
- Detachable Power Cord
- Accessories: Steaming Tray, Rice Scoop, Measuring Cup

PRC-6G/ 10G/ 12G/ 18G/ 25G/ 36G

- Keep Warm Function • Aluminium Inner Pot • Built-in Thermal Fuse

Model	PRC-6G	PRC-10G	PRC-12G	PRC-18G	PRC-25G	PRC-36G
Wattage	300W-350W	400W-477W	500W-594W	700W-833W	900W-1071W	1350W-1600W
Capacity	0.6L	1.0L	1.2L	1.8L	2.5L	3.6L
Persons	1-2	3-4	5-6	7-8	9-12	13-15
With Steam Tray	•	•	•	•	•	

PRC-6E/ 11E/ 15E/ 18E/ 28E

- Keep Warm Function • See-through Glass Lid • Built-in Thermal Fuse

Model	PRC-6E	PRC-11E	PRC-15E	PRC-18E	PRC-28E
Wattage	300W	400W	500W	700W	1000W
Capacity	0.6L	1.0L	1.5L	1.8L	2.8L
Persons	1-2	3-4	5-6	7-8	9-12
Non-stick Inner Pot		•	•	•	
Aluminium Inner Pot					•



BUILT-IN HOB

**PGH-412N**

- With Mirror Finishing
- Flame Output: 3.6kW (Left & Right)
- Low Gas Consumption
- 2 Burners with Tempered Glass Top
- Battery Operated Auto Ignition System
- Inner Dim (mm): 630 x 345
- Durable Trivet

**PGH-413N**

- With Mirror Finishing
- Flame Output: 3.6kW (Left & Right) 1.6kW (Center)
- 3 Burners with Tempered Glass Top
- Battery Operated Auto Ignition System
- Inner Dim (mm): 680 x 380
- Enamel Trivet

**PGH-422N**

- 2 Burners with Tempered Glass Top
- Flame Output: 3.6kW (Left & Right)
- Battery Operated Auto Ignition System
- Inner Dim (mm): 630 x 345
- Durable Trivet

**PGH-423N**

- 2 Burners with Tempered Glass Top
- Flame Output: 3.2kW (Left & Right)
- Battery Operated Auto Ignition System
- Inner Dim (mm): 630 x 350
- Durable Trivet

**PGH-612N**

- 2 Burners with Glass Top
- Flame Output: 4.2kW (Left & Right)
- Battery Operated Auto Ignition System
- With Safety Valve
- Inner Dim (mm): 650 x 350
- Enamel Trivet

INFRARED GAS COOKER

**PGC-165SI**

- 165 / 165mm
- Stainless Steel Body
- Auto Ignition
- Durable Trivet

SINGLE BURNER GAS COOKER

**PGC-25**

- 100mm
- Stainless Steel Body
- Single Trivet

COMMERCIAL STOVE

**PGS-30C / 40C**

- Dual Ring
- Auto Ignition
- For LPG Use Only

PORTABLE GAS COOKER

**PPG-2002N**

- 1.6kg
- Variable Flame Control
- Unique Gas Cartridge System with Liquid Guard & Refillable Cartridge
- Dim (mm): 332L x 290W x 102H



DOUBLE BURNER GAS COOKER



PGC-12S

- 100 / 100mm
- Double Bee-hive Burner
- Stainless Steel Body
- Auto Ignition
- Durable Trivet



PGC-22N

- 100 / 100mm
- Epoxy Body
- Double Bee-hive Burner
- Durable Trivet
- Auto Ignition



PGC-23N

- 100 / 100mm
- Epoxy Body
- Double Bee-hive Burner
- Durable Trivet
- Auto Ignition



PGC-26N

- 100 / 100mm
- Epoxy Coated Body
- Durable Trivet
- Auto Ignition



PGC-55S

- 120 / 120mm
- Brass Cap
- Stainless Steel Body
- Durable Trivet
- Auto Ignition



PGC-131S

- 130 / 130mm
- Cut Piece Brass Cap
- Stainless Steel Body
- Enamel Trivet
- Auto Ignition



PGC-2140S

- 140 / 140mm
- Gas-saving Up to 25%
- Stainless Steel Body
- With 7 Jet Head-burner
- Enamel Trivet
- Auto Ignition



PGC-2200G

- 120 / 120mm
- Slim Glass-top
- 8mm Tempered Glass
- Cut Piece Brass Cap
- For LPG Use
- Auto Ignition

IGNITE YOUR CULINARY PASSION

PGC-2201G

- 90 / 90mm
- Slim Glass-top
- 6mm Tempered Glass
- Cut Piece Stainless Steel Cap
- For LPG Use
- Auto Ignition



NO MORE CLOGGED BURNERS!

Uniquely designed, hidden oblique burner holes ensure burner holes stay clear longer compared to ordinary stoves.



ENVIRONMENTALLY FRIENDLY COOKING

Has higher heat efficiency to save energy and 60% lower carbon emissions than international standards requirement.



FOCUSED, POWERFUL FLAMES

Strong, 25 degree tangential whirlwind like flames deliver even and precise heat for best cooking results.



chef's like
PENSONIC
"Inspire your culinary creativity"

ENJOY AIR FRIED DELICIOUSLY CRISPY guilt-free FOOD

PDF-2201



Cooks healthier, oil-free food using high speed, hot air circulation.



Variable temperature control to prepare a variety of delectable dishes.



Non-stick cooking surface makes clean-up a breeze.



Durable, stainless steel heating element, cool touch housing and anti-skid feet.



chef's like

Pensonic Chef's Like & Dato' Chef Haji Ismail

Dato' Chef Haji Ismail, who is presently the Gastronomy Tourism Ambassador for Malaysia, helps consumers discover the joys of cooking a healthy meal through his nationwide cooking tours and TV3 cooking show, "Chef Mail Masak Bersama Pensonic". This renowned celebrity chef, who has been Pensonic Friend since 2005, uses his favourite Pensonic Chef's Like products to turn cooking into a satisfying and enjoyable experience.

Dato' Chef Haji Ismail
Dato' Chef Haji Ismail





PB-801 BLENDER

- 250W • 1.0L
- 2-Speed with Pulse & Stirrer
- Powerful Motor
- Stainless Steel Blade
- Dual Safety Lock
- Mill Attachment



PTF-5002 THERMO FLASK

- 750W • 5.0L
- Auto Reboil / Keep Warm
- 360° Swivel Base
- Stainless Steel Inner Pot
- Water Level Gauge
- 2-way Dispenser (Button / Cup)



PM-214 STAND MIXER

- 200W • 3.0L
- 5-Speed for All Mixing Needs
- Positive Beater Lock
- Light Weight for Comfort Handling
- Turbo Power
- Swivel Bowl for Even Mixing



PBM-2000 BREAD MAKER

- 650W
- 19 Preset Programmes
- 3 Loaf Size Selection (1.0LB, 1.5LB, 2.0LB)
- 3 Adjustable Crust Settings (Light, Medium, Dark)
- 15 Minutes Power Interruption Backup System
- 15 Hours Programmable Delay-start Timer
- Removable Non-stick Bowl for Easy Clean up
- Accessories: Measuring Cup, Spoon, Hook



PSM-1603 FOOD STEAMER

- 800W • 12L
- 3 Steamer Containers
- With Rice Bowl
- Water Window with Side Water Refill Facility
- 60 minutes Timer with Auto Shut Off & Chime
- Indicator Light

As featured in
WOWSI-CP



PDF-2201 AIR FRYER

- 1200 - 1400W
- High Speed Air Circulation & Oil-free Cooking Technology
- 30 Minutes Timer with Auto Shut Off & Chime
- 80°C - 200°C Adjustable Temperature to Allow a Variety of Food Preparations
- Stainless Steel Heating Element
- Cool Touch Housing & Anti-slip Feet



AE-19N OVEN

- 19L • 1380W
- Automatic Shut Off
- Heater Selector for Upper, Lower or Both
- 60 minutes Timer with Automatic Shut-off & Chime
- Adjustable Temperature Control with Indicator Light
- Tray, Tray Handle & Grid Iron Provided
- Toast, Grill, Bake



PMUJ-2004 MICROWAVE OVEN

- 20L
- Input Power: 1150W
- Output Power: 700W
- Pull Handle Door
- Painted Cavity
- Manual Control
- 6 Microwave Power Levels (Including Defrost)
- Cooking End Signal
- Cooking Timer: 0-30 Minutes



PRO-910 CONVECTION OVEN

- 1200W - 1400W
- Capacity: 12L (without extender ring) +5L (with extender ring)
- Easy Operation with Timer & Temperature Control
- Cooks Evenly
- Preserves Nutrients & Flavour of Food
- Cooks 3 to 5 Times Faster
- Functions: Roast, Bake, Toast, Grill & Warm



PSR-17N RICE COOKER

- 1.8L • 700W
- 5-8 Persons
- Keep Warm Function
- Cool-touch Housing
- Non-stick Inner Pot
- With Dew Collector
- Detachable Power Cord
- Accessories: Steaming Tray, Rice Scoop, Measuring Cup



PIC-2000 INDUCTION COOKER

- 2000W
- LCD Display Control Panel
- With Stainless Steel Soup Pot
- High Quality Ceramic Glass Cooktop
- Timer: 0 - 180 Min
- Adjustable Temperature: 80 - 270°C
- Simple 5-in-1 Function Makes Cooking Easy
- Safe & Easy to Clean with Cool Touch Cooking Surface
- Safe for Environment, Flameless & Smokeless



PMC-150C MULTI COOKER

- 5.0L • 1300W
- With Grill Pan
- Adjustable Temperature Control
- Removable Non-stick Inner Pot
- With Tempered Glass Lid
- Braising, Stir Frying, Deep Frying, Steamboat, Grilling

BUILT-IN COOKER HOOD



PCH-800S

- Power: 129W
- LED Light
- 3-Speed Control Button
- Suction Power: 600m³/h
- Product Dimensions:
895L x 475W x (Min525-Max925)H (mm)

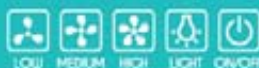

PCH-801S

- Power: 222W • LED Light
- 3-Speed Control Button
- Suction Power: 1000m³/h
- Product Dimensions:
900L x 510W x (Min510-Max910)H (mm)



PCH-802S

- Power: 221W • LED Light
- 3-Speed Smart Button
- Suction Power: 1000m³/h
- Product Dimensions:
900L x 515W x (Min550-Max900)H (mm)



PCH-803G

- Power: 221W • LED Light
- 3-Speed Smart Button
- Suction Power: 1000m³/h
- Product Dimensions:
900L x 510W x (Min565-Max915)H (mm)



PCH-804G

- Power: 222W • LED Light
- 3-Speed Control Button
- Suction Power: 1000m³/h
- Product Dimensions:
900L x 500W x (Min540-Max940)H (mm)



PCH-806G

- Power: 190W • LED Light
- 3-Speed Smart Button
- Suction Power: 800m³/h
- Product Dimensions:
900L x 500W x (Min515-Max955)H (mm)



PCH-807S

- Power: 280W • LED Light
- 3-Speed Smart Button
- Suction Power: 1200m³/h
- Product Dimensions:
895L x 500W x (Min580-Max1065)H (mm)



BUILT-IN GAS HOB



PGH-613G

- 2 Burner Hobs
- Safety Valve
- Tempered Glass
- Frame Output: (Left & Right): 4.5kW
- Product Dimensions: 780L x 460W (mm)



PGH-614G

- 3 Burner Hobs
- Safety Valve
- Tempered Glass
- Frame Output: (Left & Right): 4.5kW (Centre): 1.2kW
- Product Dimensions: 780L x 460W (mm)



PGH-615G

- 2 Burner Hobs
- Safety Valve
- Tempered Glass
- Frame Output: (Left & Right): 3.5kW
- Product Dimensions: 780L x 460W (mm)



PGH-616G

- 3 Burner Hobs
- Safety Valve
- Tempered Glass
- Frame Output: (Left & Right): 3.5kW (Centre): 1.5kW
- Product Dimensions: 780L x 460W (mm)



BUILT-IN OVEN



PBO-5603M

- Power: 3000W • 6L
- Fan Grilling • Full Grilling
- 8 Functions • Radiant Grilling
- Convectional Heat • Bottom Heat
- 3-layer Door Glass
- Mechanical Controller
- Product Dimension: 595L x 575W x 595H (mm)
- Cut Out Dimensions: 600L x 570W x 600H (mm)



PBO-5602D

- Power: 3100W • 56L
- Fan Grilling • Full Grilling
- 8 Functions • Radiant Grilling
- Convectional Heat • Bottom Heat
- LCD Display • Smart Touch
- 3-layer Door Glass
- Product Dimension: 595L x 573W x 595H (mm)
- Cut Out Dimensions: 600L x 570W x 600H (mm)



OVEN LIGHT



DEFROST



GRILL SMALL



DOUBLE GRILL



OVEN LIGHT



DEFROST



FAN GRILLING



FULL GRILLING



RADIANT GRILLING



DOUBLE GRILL WITH FAN



CONVECTIONAL COOKING



LOWER ELEMENT COOKING



CONVECTION WITH FAN



CONVECTION



CONVECTIONAL COOKING



LOWER ELEMENT COOKING

BUILT-IN MICROWAVE OVEN



PBW-2501D

- Power: 1450W • 25L
- Digital Control
- 8 Auto-cooking Programmes
- Microwave • Grill • Defrost
- Aluminium Handle Door
- With Child Lock Function
- Product Dimension: 594L x 410W x 388H (mm)
- Cut Out Dimensions: 568L x 500W x 382H (mm)



GRILL OR COMB COOKING



DEFROST BY WEIGHT



DEFROST BY TIME



2-STAGE COOKING



KITCHEN TIMER



8 AUTO MENU



SPEEDY COOKING



LOCK FUNCTION

BUILT-IN COOKER HOOD

PCH-800S

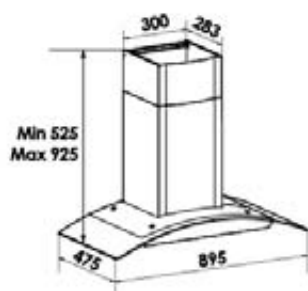

PCH-801S



PCH-802S

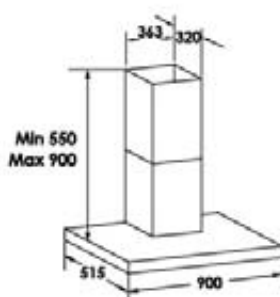

PCH-803G

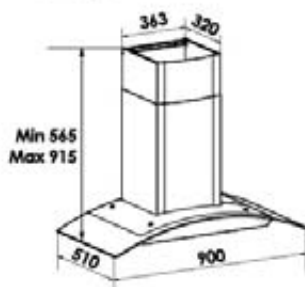

PCH-804G

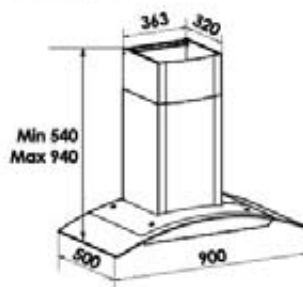

PCH-806G

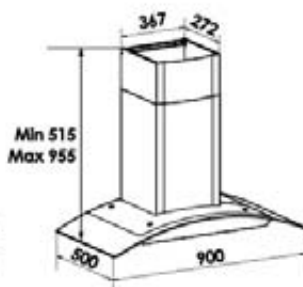

PCH-807S

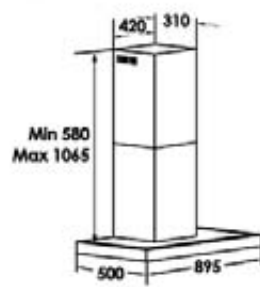

BUILT-IN MICROWAVE

OVEN PBW-2501D

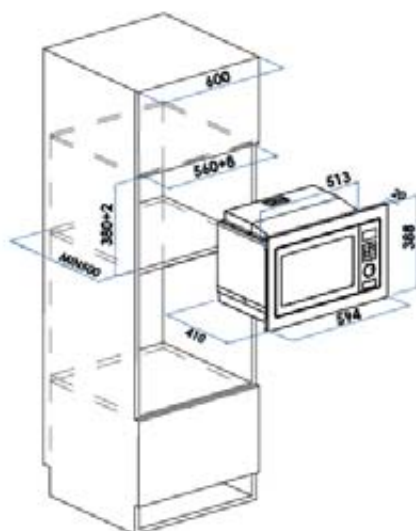

* It is advisable to use actual product for measurement prior to installation.

BUILT-IN GAS HOB

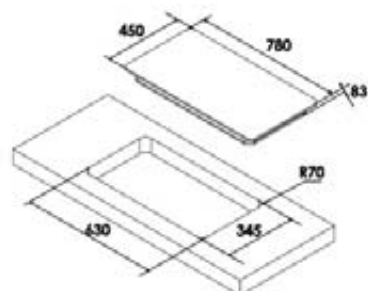

PGH-412N

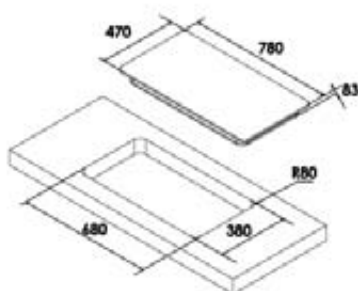

PGH-413N

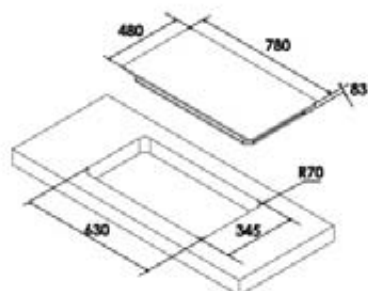

PGH-422N

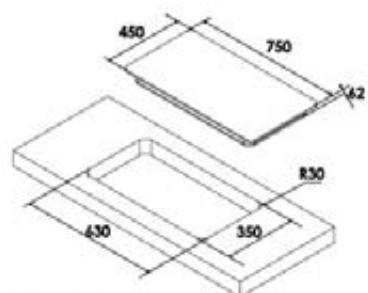

PGH-423N

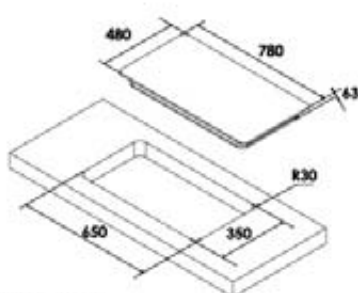

PGH-612N

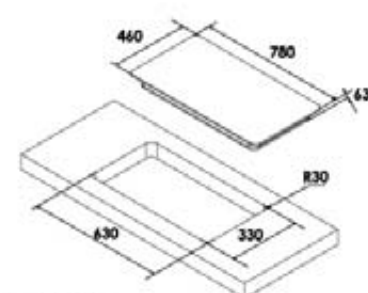

PGH-613G

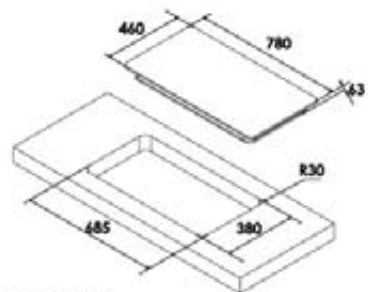

PGH-614C

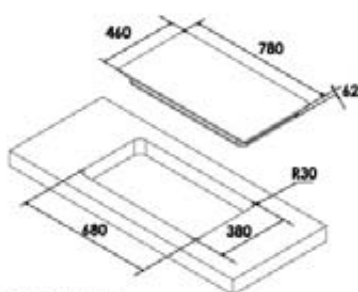

PGH-615G

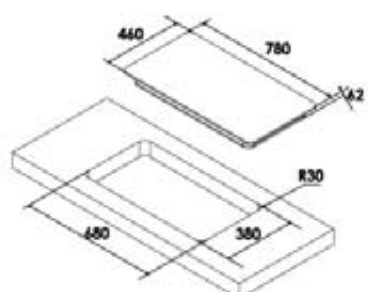

PGH-616G

BUILT-IN OVEN

PBO-5602D

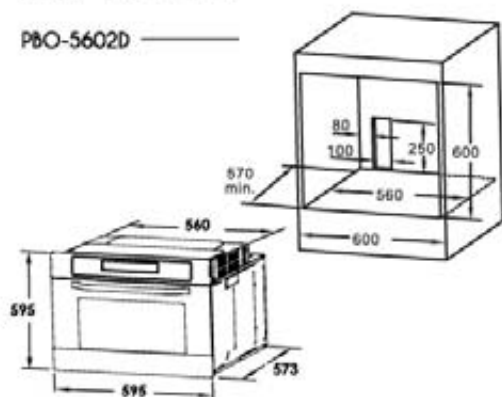

PBO-5603M

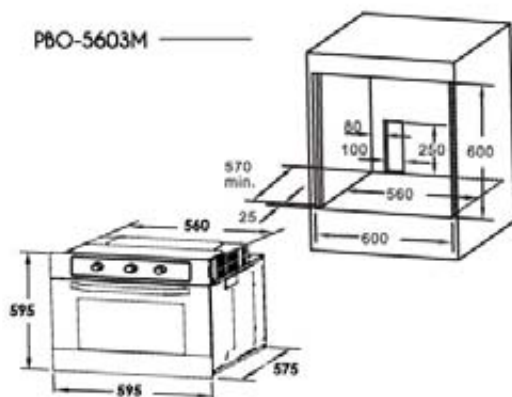



Longevity
nutritious taste of home cooking

PENSONIC

Experience the Nutritious Taste of Home Cooking with Pensonic's Longevity Series



get 2 weeks of
DETOX RECIPES



www.facebook.com/pensonicindia

A healthy and balanced diet will ensure your brain and body receive the nutrients and energy needed to increase your productivity at work, give you that youthful glow and have a better quality of life.

The Longevity Series Cookware range comprises safe and healthy rice cookers made of the nutrition enhancing Purple Clay, ceramic double boilers and steamer to help you prepare food the easy way to lock in essential nutrients while retaining its natural colour, flavour and taste. The result is deliciously healthy food that is nutritious and fresh, with the tasty goodness of a home cooked meal.



PRC-20AC PURPLE CLAY MULTI-PURPOSE RICE COOKER

- A variety of rice cooking options such as White Rice, Clay Pot Rice, Glutinous Rice, Congee, Soup.
- 2L high quality Purple Clay inner pot ensures thorough and nutritious cooking while preserving natural flavour of food.
- Double Purple Clay lid cooking method effectively seals in nutrition.
- Timer can be set to begin cooking by a desired time up to a maximum of 9.9 hours.
- 8 hours Keep Warm function ensures food is kept warm until required.
- 600W

2L High Quality Purple Clay Inner Pot



X2 Lid effectively seals in nutrition





PSR-30AC PURPLE CLAY RICE COOKER

- Cooks fluffy rice, nourishing porridges and soups.
- Bigger capacity 3L high quality Purple Clay inner pot facilitates optimum cooking, keeping nutrition and taste intact.
- Double lid cooking method effectively seals in nutrition.
- 8 hours Keep Warm function ensures food is kept warm until required.
- 500W

**3L High Quality
Purple Clay
Inner Pot**



**X2 Lid
effectively seals
in nutrition**



PDB-283 CERAMIC DOUBLE BOILER

- Ideal for making sumptuous stews, appetising steamed dishes and light porridges with 8 preset computerised control modes.
- Comes with a 2.2L and two 0.5L ceramic pots to prepare many dishes in one go, saving time and energy.
- Timer can be set to complete cooking by a desired time up to a maximum of 9.5 hours.
- Boil dry protection safety feature will shut off appliance when there is no liquid in the pot.
- Transparent lid allows viewing of cooking progress while ceramic inner pot facilitates even cooking.
- 380-470W



PDB-453 CERAMIC DOUBLE BOILER

- Ideal for making sumptuous stews, appetising steamed dishes and light porridges with 8 preset computerised control modes.
- Comes with a 2.5L and three 0.5L ceramic pots to prepare many dishes in one go, saving time and energy.
- Timer can be set to complete cooking by a desired time up to a maximum of 9.5 hours.
- Boil dry protection safety feature will shut off appliance when there is no liquid in the pot.
- Glass lid allows viewing of cooking progress while ceramic inner pot facilitates even cooking.
- 400-500W



PSM-1604 CERAMIC STEAMER

- Comes with 7 preset computerised control modes including Rice, Meat, Corn, Chicken, Ribs, Vegetables and Dessert.
- Two 3.0L ceramic trays are provided to allow preparation of two tasty dishes simultaneously to save time and energy.
- Timer can be set to complete cooking by a desired time up to a maximum of 9.5 hours.
- Transparent water level indicator and double water inlets help in easy filling of water.
- Boil dry protection safety feature will shut off appliance when there is no liquid in the pot.
- 650-775W



3.0L



3.0L



life is such a BREEZE

PAC-323



KEEP YOUR COOL

Cyclonic cooling technology delivers cool and moist targeted air, making it easier to breathe.



FRESH BREATH OF AIR

Honeycomb and dust proof filter ensures efficient filtration of air and water circulating through the cooler for cleaner air.



3-IN-1

Fan, Air Cooler Humidifier and Ioniser boosts freshness of air and improves air quality by reducing harmful air particles and static electricity.

AIR COOLER

PAC-105M

- 65W
- 3 Fan Speeds (1/ 2/ 3)
- With Honeycomb Filter, Dust-proof Filter & 7L Water Tank
- Horizontal Auto-swing & Manually Adjustable Vertical Air Flow
- Excellent Cyclic Sprinkling Water Pump System for Optimum Humidity, Cool & Fresh Air
- 2 Ice-packs for Cooler Effect



PAC-101M

- 60W • Excellent Cyclic Sprinkling Water Pump System for Optimum Humidity, Cool & Fresh Air
- 3 Fan Speeds (Hi / Med / Low)
- Horizontal Auto-swing & Manually Adjustable Vertical Air Flow
- With Honeycomb Filter, Dust-proof Filter & Removable Water Tank
- 2 Ice Packs for Cooler Effect
- Mechanical Control Panel
- Removable 4L Water Tank



PAC-102

- 65W • Removable 6L Water Tank
- 3 Fan Speeds (Hi / Med / Low)
- Eco-friendly, Honeycomb Design Vent for Maximum Cooling and Fresher Air
- With Ioniser for Purer Air
- Full Function Remote Control with 7.5 Hour Timer
- Large Compartment to Fit 2 Ice-packs for Increased Cooling Effect



PAC-103

- 60W • 3 Fan Speeds (Hi / Med / Low)
- 3 Wind Modes (Normal / Natural / Sleeping)
- Excellent Water Pump Sprinkling Cyclic System for Optimum Humidity, Cool & Fresh Air
- 3-in-1 Combination of Fan, Air Cooler Humidifier & Ioniser
- Horizontal Auto-swing & Manually Adjustable Vertical Air Flow
- With Honeycomb Filter, Dust-proof Filter & Removable 6L Water Tank
- 2 Ice-packs for Cooler Effect
- Multi-function Control Panel with Remote Control



PAC-104M

- 65W
- 3 Fan Speeds (1/ 2/ 3)
- With Honeycomb Filter, Dust-proof Filter & 7L Water Tank
- Horizontal Auto-swing & Manually Adjustable Vertical Air Flow
- Excellent Cyclic Sprinkling Water Pump System for Optimum Humidity, Cool & Fresh Air
- 2 Ice-packs for Cooler Effect



PAC-303I

- 65W • Pure Natural Plant Fiber Cooler Master for Effective Cool & Fresh Air
- With Ion Function • 7.5 Hours Timer
- Infrared Remote Control with LED Display
- 3 Fan Speeds (Hi / Mid / Low)
- Horizontal Auto-swing & Manually Adjustable Vertical Air Flow
- With Honeycomb Filter & Dust Proof Filter
- 8L Large Capacity Water Tank



PAC-322

- 65W • Removable 2.5L Water Tank
- 3 Fan Speeds (High, Medium, Low)
- With Ioniser for Purer Air
- Full Function Remote Control with 7.5 Hour Timer
- Eco-friendly, Honeycomb Design Vent for Maximum Cooling and Fresher Air
- Large Compartment to Fit 2 Ice-packs for Increased Cooling Effect





PAC-323

- 160W • Removable 20L Water Tank
- 3 Fan Speeds (High, Medium, Low)
- 2-wind Mode (Normal / Sleep)
- 3-in-1 Combination of Fan, Air Cooler Humidifier & Ionizer
- Multi-function Control Panel with Remote Control
- 24-hour Timer
- Horizontal & Vertical Auto-swing
- With Honeycomb Filter & Dust-proof Filter
- 2 Ice-packs for Cooler Effect
- Excellent Water Pump Sprinkling Cyclic System for Optimum Humidity, Cool & Fresh Air



PAC-325

- 80W • Removable 4L Water Tank
- 3 Speeds with 3 Wind Modes (Natural/Normal/Sleep)
- With Honeycomb Filter, Dust-proof Filter
- Full Function Remote Control with 7.5 hour timer
- Horizontal Auto-swing & Manually-adjust Vertical Air Flow
- Excellent Cyclic Sprinkling Water Pump System for Optimum Humidity, Cool & Fresh Air
- 2 Ice-packs for Cooler Effect



PAC-2001RI

- 55W • 3L Water Tank
- 3 Speeds with 3 Wind Modes (Natural/Normal/Sleep)
- 1-9 hours timer
- With Ionizer to Purify Air
- 80 Degree Oscillation
- Digital Display and Remote Control
- Removable Back Cover with Safety Switch
- Sprinkling Cycling System Water Pump Assists in Cooling the Room Temperature with Ice and Water
- Space Saving Slim Design

MIST FAN



PAC-320H

- 90W • 3-in-1 Combination of Fan, Ultrasonic Mist Humidifier & Ioniser
- 9-hour Timer • 2.5L Water Tank
- With 4 Wheels, Easy to Move
- 3 Fan Speeds (Hi / Mid / Low)
- Multi Function Remote Control & Colourful LED Display
- The Photocatalyst Function Can Break Down Harmful Substances in The Air & Inhibits Bacteria Growth



PAC-321H

- 90W • 3-in-1 Combination of Fan, Ultrasonic Mist, Humidifier & Ioniser
- 9-hour Timer • 2.5L Water Tank
- With 4 Wheels, Easy to Move
- 3 Fan Speeds (Hi / Mid / Low)
- Multi Function Remote Control & Colourful LED Display
- The Photocatalyst Function Can Break Down Harmful Substances in The Air & Inhibits Bacteria Growth

CIRCULATION FAN



PF-50901

- 45W • 9"
- 3-speed Control
- Manually Adjustable 90° vertical air flow
- Motor with Safety Fuse



PF-50902

- 45W • 9"
- 3-speed Control with Fixed Angle / Auto Oscillation
- Manually Adjustable 90° Vertical Air Flow
- 70° Horizontal Auto Oscillation
- Motor with Safety Fuse

TABLE FAN



PF-41A

- 50W • 16" (400mm)
- 3-Speed
- Motor with Safety Fuse



PF-41B

- 50W • 16" (400mm)
- 3-Speed
- Motor with Safety Fuse



PF-3100

- 35W • 12" (300mm)
- 3-Speed
- Motor with Safety Fuse



AF-30B

- 35W • 12" (300mm)
- 3-Speed
- Motor with Safety Fuse



PF-4100

- 50W • 16" (400mm)
- 3-Speed
- Motor with Safety Fuse



BOLD

TO BE LONG

BE DARING. GET A BOLD FAN

The stylish BOLD Fan's durable motor, sturdy base and robust blades are shaped for maximum wind production, to keep you unbelievably cool even in the hottest weather. Comes with a definitely not to be missed quality guarantee of one to one exchange warranty for one year.

Terms & Conditions apply.

 SOLID
BASE

 INCREDIBLE
WIND

 POWERFUL
MOTOR



PF-4102

- 16" TABLE FAN
- 50W • 3-SPEED
- HEAVY BASE FOR STABILITY
- MOTOR WITH SAFETY FUSE



PSF-4502

- 16" STAND FAN
- 60W • 3-SPEED
- STRONG BASE & MOTOR
- MOTOR WITH SAFETY FUSE



PF-3102

- 12" TABLE FAN
- 35W • 3-SPEED
- HEAVY BASE FOR STABILITY
- MOTOR WITH SAFETY FUSE



“ ONE to ONE
exchange warranty ”



WALL FAN

**PWF-4801R**

- 50W • 16" (400mm)
- 3-Speed
- With Remote Control
- Random / Sleep Mode / Timer / Rhythm / Speed
- Motor with Safety Fuse

**PWF-48**

- 50W • 16" (400mm)
- 3-Speed
- Motor with Safety Fuse

**PWF-68**

- 50W
- 16" (400mm)
- 3-Speed
- Motor with Safety Fuse

**PWF-18A**

- 70W
- 18" (450mm)
- 3-Speed
- Metal Fan Blades

INDUSTRIAL FAN

PWF-2000

• 20" • 120W

PWF-2600

• 26" • 160W

PWF-3000

• 30" • 200W

- 3-Speed Rotary Control
- With Swing Function
- 2 Metal Blades for Maximum Air Flow
- Motor with built-in Thermal Protection

**PWF-20A**

- 155W • 20" (470mm)
- 3-Speed Rotary Control
- With Swing Function
- 3 Metal Blades for Maximum Air Flow
- Motor with built-in Thermal Protection

**PSF-2000**

• 20" • 120W

PSF-2600

• 26" • 160W

PSF-3000

• 30" • 200W

- 3-Speed Rotary Control
- Height Adjustable
- 2 Metal Blades for Maximum Air Flow
- With Swing Function
- Motor with built-in Thermal Protection

**PFF-18B**

- 70W • 18" (450mm)
- 3-Speed Rotary Control
- 3 Metal Blades for Maximum Air Flow

**PFF-18C**

- 130W • 18" (450mm)
- 3-Speed Rotary Control
- 3 Metal Blades for Maximum Air Flow

**PFF-1800 PFF-2000**

• 18" • 115W • 20" • 155W

- 4-Speed Rotary Control
- 3 Metal Blades for Maximum Air Flow
- With Swing Function
- Motor with built-in Thermal Protection

BOX FAN

PBF-147

- 60W • 16" (400mm)
- 3 fan Speeds
- With 2-hour Timer Function
- Rotating Louver with On / Off Switch



EXHAUST FAN

**PEX-060/ 080/ 100/ 120**

- Low Noise Operation • Highly Efficient Motor for Energy Saving • Highly Efficient Air Delivery
- Automatic Shutter • Easy Installation and Cleaning • Motor with Safety Fuse

Model	PEX-060	PEX-080	PEX-100	PEX-120
Size (inc.)	6"	8"	10"	12"
Power (W)	25	30	35	45
Air Delivery (m ³ /min)	4.1	8.1	12.0	18.0
Speed (rpm)	1350-1500	1200-1450	1100-1400	1050-1350
Sound Level (dB)	40	42	45	52
Net Weight (kg)	1.50	2.06	2.30	2.95



TOWER FAN

**PTW-111**

- 45W
- Height: 29"
- 3-Speed
- Oscillation Function
- 2-hour Timer
- Rotary Switch

**PTW-200 / 200R**

- 50W
- Height: 40"
- 3-Speed
- Wide Angle Automatic Swing
- Removable Rear Cover for Easy Cleaning
- 2-hour Timer
- Easy Operation Control Panel

PTW-200R

- 7-hour Timer
- Multi-function with LED Indicator
- Natural Mode Function
- Multi-function Remote Control
- Easy Operation Self Touch Control Panel

**PTW-201RI**

- 65W
- Height: 40.5"
- 3-Speed
- 3 Wind Modes
- 90° Horizontal Oscillation
- 1, 2, 4, 8-hour Timer Function
- Elegant Design with LED Display
- With Remote Control

**PTW-202RI**

- 65W
- Height: 40.5"
- 3-Speed
- 3 Wind Modes
- 90° Horizontal Oscillation
- 1, 2, 4, 8-hour Timer Function
- Elegant Design with LED Display
- With Remote Control

**PTW-203RI**

- 70W
- Height: 44"
- 3-Speed
- Selectable Single or Dual Fan Blow Function
- 3 Wind Modes (Normal/ Natural/ Sleeping)
- 80° Horizontal Oscillation
- 1, 2, 4, 8-hour Timer Function



CEILING FAN

PCF-60B

- 85W • 60" (1500mm)
- Pure Copper Motor
- 5-Speed Regulator Control
- Double Ball Bearing

STAND FAN

**PSF-18**

- 70W
- 3-Speed
- 18" (450mm)
- Wide Angle Automatic Swing
- 3 Slim Aerodynamic Blades
- Heavy Steering Base for Stability

**PSF-45**

- 50W
- 3-Speed
- 16" (400mm)
- Motor with Safety Fuse

**PSF-45B**

- 50W
- 3-Speed
- 16" (400mm)
- Motor with Safety Fuse

**PSF-60S**

- 60W
- 16" (400mm)
- With LCD Display
- Ioniser Function
- Special 4-in-1 Multi-oscillating Function
- With Remote Control
- Motor with Safety Fuse

**PSF-360**

- 50W
- 3-Speed
- 16" (400mm)
- With 360° Rotation & Up-down Oscillation
- 2 Wind Modes: Normal & Rhythmic
- LCD Display with 8 Hours Timer
- 13-Angle Oscillation Mode: 0°, 30°, 60°, 90°, 120°, 150°, 180°, 210°, 240°, 270°, 300°, 330° & 360°
- With Remote Control and Memory Function

**PSF-4500**

- 50W
- 3-Speed
- 16" (400mm)
- Motor with Safety Fuse

**PSF-4601 / PSF-4602R**

- 50W
- 3-Speed
- 16" (400mm)
- Special 4-in-1 Multi-Oscillating Function
- Motor with Safety Fuse

PSF-4602R

- Rhythmic Mode
- With Remote Control



VACUUM CLEANER

PVC-3102C

- 1800W • 2.5L
- Bagless Cyclonic System
- Swivel Front Wheel for Easy Movement
- Strong Suction Power
- Accessories:
Plastic Tubes, Plastic Floor Brush,
Flexible Hose and Crevice Tool



1800W
CYCLONE
Vacuum Cleaner



PVC-2200

- 1220W
- 1.5L
- Powerful Motor
- Swivel Front Wheel
- Safety Valve
- Power Regulator
- Strong Suction Power
- Bagless Cyclonic System



PVC-22B

- 1200W
- 3.0L
- Automatic Cord Rewinder System
- Dust Bag Full Indicator
- 5 Layer Filtration System
- Cord Length: 5.0M
- Foot Pedal for On / Off



PVC-211

- 1200W
- 3.2L
- Strong Blowing Function
- Washable Filter
- Dry / Wet / Blow Vacuum Cleaner
- Durable Plastic Blow Tank
- Powerful Suction for Waste Water



PVC-3101

- 2000W
- 4.5L
- Powerful Motor
- Swivel Front Wheel
- Safety Valve
- Power Regulator
- Strong Suction Power
- Dust Bag Full Indicator
- Cord Rewind System
- Accessories:
Plastic Tubes, Plastic Floor Brush,
Flexible Hose, Crevice Tool and Dust Bag



PVC-3600S

- 1850W • 3.6L
- Dry / Wet / Blow Vacuum Cleaner
- Powerful Suction for Waste Water with Accessories
- Strong Blowing Function with Lower Noise
- Washable Filter • Stainless Steel Tank
- Accessories:
Master Nozzle, Squeeze Nozzle, Crevice Tool, Ellipse Brush and Extension Wands

INSECT KILLER

PIK-11

- 15W
- Safe & Natural Way to Trap Mosquitoes
- Chemical Free - Non Poisonous & Odourless
- Quiet & Reliable DC Fan - Low Power Consumption 15W
- Built-in Funnel to Prevent Mosquito Escape
- Dimet UV Light with Reliable / Stable Wave Length
- Photo Sensor to Switch On / Off
- Effective Area: 60M²



PIK-22

- 15W
- Safe & Natural Way to Trap Mosquitoes
- Chemical Free - Non Poisonous & Odourless
- Quiet & Reliable DC Fan - Low Power Consumption 15W
- Built-in Funnel to Prevent Mosquito Escape
- Dimet UV Light with Reliable / Stable Wave Length
- Effective Area: 60M²



MULTIPURPOSE LIGHT

PEL-3T

- 360° Light Distribution
- 3 / 2 / 1 Fluorescent Tube Function Selector
- Emergency Light
- Green LED Operating Indicator
- Red LED Charging Indicator
- 6V 4Ah Sealed Lead Acid Rechargeable Battery
- 3 x 10W Fluorescent Tube
- Operation Hours: 1.5-6 Hours
- Suitable for Camping, Fishing



oQua

de Splash

Experience Sheer
Showering Pleasure

PWH-1001SPR / 1000SPR

- With DC Silent Pump • Mesh Filter
- Double Safety Protection
- 5 Spray Pattern Handshower
- Variable Temperature Control
- Splash Proof Protection
- Suitable for High and Low Water Pressure
- 3 In 1 Stop Valve with Rain Shower Set

PWH-1001SPR

PWH-1000SPR



PWH-911SP

PWH-910SP

PWH-911E

PWH-910E

PWH-911EP



- With DC Silent Pump • Double Safety Protection
- 5 Spray Pattern Handshower • Mesh Filter
- Variable Temperature Control • 3 In 1 Stop Valve
- Suitable for High and Low Water Pressure
- Splash Proof Protection

- Double Safety Protection • 5 Spray Pattern Handshower
- Variable Temperature Control • Mesh Filter
- Suitable for High and Low Water Pressure
- 3 In 1 Stop Valve • Splash Proof Protection

- With AC Pump • Double Safety Protection
- 5 Spray Pattern Handshower • Mesh Filter
- Variable Temperature Control
- Suitable for High and Low Water Pressure
- 3 In 1 Stop Valve • Splash Proof Protection

PWH-968E

PWH-968EP



- Double Safety Protection
- 5 Spray Pattern Handshower
- Variable Temperature Control • Mesh Filter
- Suitable for High and Low Water Pressure
- 3 In 1 Stop Valve • Splash Proof Protection

- With AC Pump • Double Safety Protection
- 5 Spray Pattern Handshower • Mesh Filter
- Variable Temperature Control
- Suitable for High and Low Water Pressure
- 3 In 1 Stop Valve • Splash Proof Protection

MULTI
SPRAY
HAND SHOWER



PENSONIC FIGHTER

AIR CONDITIONER



Self-Diagnosis



Turbo Cooling



Dehumidifies

R410A New Series Split Air Conditioner Specification Sheet

MODEL	INDOOR UNIT		1.DHP	1.SHP	2.DHP	2.SHP	
	OUTDOOR UNIT		PSW-1019	PSW-1519	PSW-2019	PSW-2519	
			PCU-1019	PCU-1519	PCU-2019	PCU-2519	
Cooling Capacity		Btu / h	8871	11000	17998	22001	
		W	2600	3224	5275	6448	
Power Sources		V / Hz	220 - 240 / 50				
Cooling Capacity	Rated Input Power	W	1200	1400	2200	2950	
	Rated Input Current	A	5.57	7.72	12.00	14.70	
Air Flow Volume	Indoor Unit	m ³ / h	500	600	850	950	
	Outdoor Unit	m ³ / h	1200	1600	1800	3200	
Dehumidifying Volume		l / h	0.8	1.4	1.8	2.0	
Energy Efficiency Ratio (EER)		Btu / h / w	9.73	10.16	11.48	10.01	
Motor Output	Indoor Fan	W	10	20	20	35	
	Outdoor Fan	W	20	35	45	60	
Fan Type - Piece	Indoor Fan	Type	Cross Flow Fan				
	Outdoor Fan	Type	Axial Flow Fan				
Evaporator		Type	Aluminum Fin-Copper Tube				
Sound Pressure Level	Indoor Fan	dB(A) / S / H / M / L	39 / 36 / 33 / 30	42 / 39 / 36 / 33	46 / 42 / 37 / 34	47 / 42 / 38 / 34	
	Outdoor Fan	dB(A)	50	52	52	53	
Unit Dimensions	Indoor Fan	W x H x D (mm)	790 x 265 x 186	848 x 275 x 180	940 x 298 x 200	1007 x 315 x 219	
	Outdoor Fan	W x H x D (mm)	720 x 428 x 310	776 x 540 x 320	848 x 540 x 320	955 x 700 x 396	
Dimensions of Package	Indoor Fan	W x H x D (mm)	873 x 251 x 370	918 x 258 x 370	1013 x 383 x 300	1076 x 398 x 328	
	Outdoor Fan	W x H x D (mm)	768 x 353 x 490	823 x 358 x 595	881 x 363 x 595	1029 x 458 x 750	
Net Weight	Indoor Fan	Kg	9.0	10.0	12.0	15.0	
	Outdoor Fan	Kg	25.0	27.0	39.5	51.0	
Gross Weight	Indoor Fan	Kg	10.5	12.0	15.0	18.5	
	Outdoor Fan	Kg	27.0	31.0	42.0	55.5	
Compressor		Type	Rotary				
Climate Type			T1	T1	T1	T1	
Isolation			I	I	I	I	
Refrigerant Charge		Kg	R410A / 0.56	R410A / 0.57	R410A / 0.93	R410A / 1.35	
Connection Pipe	Length	M	5	5	5	5	
	Gas Additional Charge	g/m	15	15	15	15	
	Copper Pipe Size	Liquid Pipe	inch	1 / 4"	1 / 4"	1 / 4"	1 / 4"
		Gas Pipe	inch	3 / 8"	1 / 2"	1 / 2"	5 / 8"
	Max Distance	Height	M	10	10	10	10
Length		M	15	20	25	25	
Automatic Operation			√	√	√	√	
Cooling			√	√	√	√	
Dehumidify			√	√	√	√	
Sleep Mode			√	√	√	√	
Timer			√	√	√	√	
Fan			√	√	√	√	
LED Display			√	√	√	√	
Vertical Auto Swing			√	√	√	√	
Air Flow			√	√	√	√	
Memory Function			√	√	√	√	
Dry Anti-mildew Design			√	√	√	√	
Auto Fan			√	√	√	√	
Self Diagnosis			√	√	√	√	
Turbo Cooling			√	√	√	√	
Energy Efficiency			★★	★★	★★★★	★★★★	

Memory Function Timer Self-Diagnosis LED Display Wide Angle Louvers "Turbo" Button Removable & Washable Filter Dehumidifying



KEEP COOL!!!

FRESH COOL

PORTABLE AIR CONDITIONER

Pensonic's Fresh Cool Air Conditioning series gives you maximum flexibility in air cooling with its portable air conditioner. With no installation required, it is also easy to move around. Own this well-designed portable air conditioner to cater to your cooling needs anytime and anywhere!



Portable Air Conditioner Specification Sheet

MODEL		PPA-109	PPA-159
Cooling Capacity	Btu / h	9000	12000
Power Sources	V / Hz	220-240 / 50	
Cooling	Rated Input Power	1300	1550
	Rated Input Current	5.6	6.7
Air Flow Volume	m ³ / h	420 / 390 / 300	450 / 420 / 390
Dehumidifying Volume	l / h	1.2	1.5
Energy Efficiency Ratio (EER)	W / W	2.60	2.61
Motor Output	W	18	23
Fan Type	-	Centrifugal	
Evaporator	-	Aluminum Fin-Copper Tube	
Climate Type	-	T1	T1
Isolation	-	I	I
Sound Pressure Level	dB(A) / H / M / L	56 / 54 / 52	58 / 56 / 54
Unit Dimensions	W x H x D (mm)	450 x 840 x 400	500 x 840 x 460
Dimensions of Package	W x H x D (mm)	533 x 863 x 488	584 x 877 x 539
Net Weight	Kg	36.0	45.0
Gross Weight	Kg	41.0	52.5
Compressor	Type	Rotary	
Refrigerant Charge	Kg	R410A / 0.58	R410A / 0.80
Dehumidifier		√	√
Sleep Mode		√	√
Timer		√	√
Vertical Auto Swing		√	√
Air Flow		√	√
Memory Function		√	√
Dry Anti-mildew Design		√	√
Auto Fan		√	√
Self Diagnosis		√	√
LED Display		√	√

PARTY MONSTER

Mini Combo

PCD-1001BT

This compact and portable Mini Combo enhances your listening pleasure with mesmerising music, richer sounds and delivers convenience with bluetooth and other easy to use functions.



BLUETOOTH COMPATIBLE

Pair this CD Player with your favourite devices using Bluetooth for a variety of exciting possibilities.



MP3 PLAYER

Built in USB port with MP3 player takes your music to a whole new level of accessibility.



FM RADIO WITH PLL TUNING

Listen to your favourite radio stations all day with FM PLL tuning.

PORTABLE RADIO

**PPR-01**

- AC / DC 6V Operation
- Built-in Rechargeable Battery
- With Each Charge, Radio Works 10-15 Hours Continuously
- With Each Charge, USB / SD Works 2 Hours Continuously
- With Remote Control
- Auto Scan FM Tuner (FM88 - 108MHz)
- USB / SD Input (max 8G)
- AUX In Jack
- PC-USB Cable (Power Supply / Charging)

**PPR-03**

- DC 5V
- Rechargeable Battery - BL-5C
- Auto Scan FM Tuner (FM88 - 108MHz)
- USB / SD Input (max 8G)
- AUX In Jack
- PC-USB Cable (Power Supply / Charging)

**PPR-05**

- DC 5V
- With Remote Control
- Rechargeable Battery - BL-5C
- Auto Scan FM Tuner (FM88 - 108MHz)
- USB / SD Input (max 8G)
- AUX In Jack
- PC-USB Cable (Power Supply / Charging)

**PPR-06**

- DC 5V
- With Remote Control
- Rechargeable Battery - BL-5C
- Auto Scan FM Tuner (FM88 - 108MHz)
- USB / SD Input (max 8G)
- AUX In Jack
- PC-USB Cable (Power Supply / Charging)

CD PLAYER

PCD-1001BT**CD / MP3 PLAYER**

- AC / DC Operation
- LED Disco Light
- Analog Tuning with Digital Readout
- LCD Negative Display
- USB Input Compatible with MP3
- Bluetooth Feature
- Aux In + Phone Jack
- Uses 8 pcs "UM-1/D" Batteries
- Output Power (RMS): 12.5W x 2
- 48W

**PCD-8102BT****CD / MP3 PLAYER**

- AC / DC Operation
- FM PLL Tuning
- LCD Display
- USB Input Compatible with MP3
- Bluetooth Feature
- Aux In + Phone Jack
- Uses 6 pcs "UM-2/C" Batteries
- Output Power (RMS): 1.2W x 2
- 14W

**PCD-8103BT****CD / MP3 PLAYER**

- AC / DC Operation
- Auto Stop Mechanism
- FM PLL Tuning
- LCD Display with Backlight
- USB Input Compatible with MP3
- Bluetooth Feature
- Cassette Player
- Aux In + Phone Jack
- Uses 6 pcs "UM-1/D" Batteries
- Output Power (RMS): 1.5W x 2
- 12W

**PCD-8104BT****CD / MP3 PLAYER**

- AC / DC Operation
- Analog Tuning with Digital Readout
- LCD Display with Backlight
- USB Input Compatible with MP3
- Bluetooth Feature
- Aux In + Phone Jack
- Uses 6 pcs "UM-1/D" Batteries
- Output Power (RMS): 1.2W x 2
- 18W

**PCD-901****VCD / CD / MP3 PLAYER**

- AC / DC Operation
- LCD Display
- USB/SD/MMC Card Reader
- AM / FM Tuner
- Bass Boost System
- Built-in Microphone
- Cassette Player
- Uses 8 pcs "UM-2" Batteries



LED TV



PLED-2208

- 22 Inch LED TV
- Resolution: 1680x1050 WSXGA
- High Brightness: 300 cd/m
- Dynamic Contrast Ratio: 7000:1
- Fast Response Time: 5ms
- Superb Display Colour: 16.7 Million
- Large Memory Channel: 200
- Photo/Music/video
- 1x AV IN
- 1x RF Turner
- 1x HDMI
- 1x VGA
- 1x USB
- 1x PC Audio In
- 1x Earphone Jack



PLED-2409

- 24 Inch LED TV
- Resolution: 1366x768 HD READY
- High Brightness: 300 cd/m
- Dynamic Contrast Ratio: 7000:1
- Fast Response Time: 5ms
- Superb Display Colour: 16.7 Million
- Large Memory Channel: 200
- Photo/Music/video
- 2x AV IN
- 1x RF Turner
- 1x HDMI
- 1x VGA
- 1x USB
- 1x PC Audio In
- 1x Earphone Jack



PLED-3208

- 32 Inch LED TV
- Resolution: 1366x768 HD Ready
- High Brightness: 350 cd/m
- Dynamic Contrast Ratio: 10000:1
- Fast Response Time: 5ms
- Superb Display Colour: 16.7 Million
- Large Memory Channel: 200
- Photo/Music/video
- 2x AV IN
- 1x RF Turner
- 1x HDMI
- 1x VGA
- 1x USB
- 1x PC Audio In
- 1x Earphone Jack



PLED-4008

- 40 Inch LED TV
- Resolution: 1920x1080 Full HD
- High Brightness: 400 cd/m
- Dynamic Contrast Ratio: 10000:1
- Fast Response Time: 5ms
- Superb Display Colour: 16.7 Million
- Large Memory Channel: 200++
- Photo/Music/video
- 2x AV IN
- 1x RF Turner
- 2x HDTV Input
- 1x Earphone Jack
- 1x VGA
- 1x USB (Side)
- 1x PC Audio In



DVD PLAYER



PDVD-8203

- DVD / CD / PAL-NTSC
- Full Remote Control System
- Full Karaoke Function
- Multi Zone Code & Parental Lock
- 2.0ch Analogue Audio Output
- CD-R / CD-RW / MPEG Decoder
- Supports 32 Subtitles



PDVD-8204

- DVD / CD / PAL-NTSC
- Full Remote Control System
- Full Karaoke Function
- Multi Zone Code & Parental Lock
- 2.0ch Analogue Audio Output
- CD-R / CD-RW / MPEG Decoder
- Supports 32 Subtitles



PDVD-9301RM

- DVCD / SVCD / VCD / CD / CD-R / CD-RW / DVD-RW / AUTO TV / PAL-NTSC / DVD+RW / KODAK Picture CD / JPEG
- Full Remote Control System
- Full Karaoke Function with Digital Echo Effect
- RM / RMVB Compatible Digital Media Player
- Multi Zone Code & Parental Lock



PDVD-9304H

- DVCD / DVD / VCD / CD / CD-R / CD-RW / DVD+R / HD Mode / DVD+RW / KODAK Picture CD / PAL-NTSC
- Full Remote Control System
- Full Karaoke Function
- Multi Zone Code & Parental Lock



PDVD-9904

- DVD / SVCD / CD / PAL / NTSC Compatibility / CD-R / CD-RW / MPEG decoder
- Full remote control system
- Full Karaoke Function
- Multi Zone Code & Parental Lock
- Support 32 Subtitles



PDVD-9905

- DVD / SVCD / CD / PAL / NTSC Compatibility / CD-R / CD-RW / MPEG decoder
- Full remote control system
- Full Karaoke Function
- Multi Zone Code & Parental Lock
- Support 32 Subtitles



WATER FILTER CARTRIDGE

PP-123R1
CARBON BLOCK

- 5.0 Micron Filtration for Reduction of Cryptosporidium and Giardia (VOCS)
 - Polishing Filter for Excellent Drinking Water
 - Class I Chlorine, Taste & Odour Reduction
- For Model: PP-123

PP-123R2
SEDIMENT FILTER

- Polypropylene Replacement Cartridge
 - For Removal of Sand, Silt, Dirt & Rust
 - Maximum Housing Temperature: 125°F (52°C)
 - Water Flow: 20 Litre per Minute
- For Model: PP-123

PMP-15R1
MINERAL STONES

- Enriches Essential Mineral Contents, Oxygen in the Water
 - Controls Water pH to Mild Alkaline
 - Keeps Water Fresh & Active
- For Model: PMP-15

PMP-15R2
CERAMIC DOME

- Micron Size: 0.9 - 0.5 Micron
 - Filtration that Blocks Sediment Particles such as Dirt, Rust and also Bacteria
- For Model: PMP-15

VACUUM CLEANER BAG

PVB-03PM

- 1 pack consists of 4 pcs
- For Model: PVC-225, 31A, 25A

PMP-15R3
4-STEP FILTRATION SYSTEM

- Step 1: Activated Carbons Remove Chlorine, THMs Organic Chemicals, Unpleasant Odours & Colours
 - Step 2: Silica Sand Removes Acidic Components from the Water
 - Step 3: Zeolite Removes Heavy Metals
 - Step 4: Mineral Sand Release Minerals & Adjust pH of Water to Mild Alkaline
- For Model: PMP-15

GAS REGULATOR

PLPG-1000

- Zinc Base & Aluminum Cover with POM Control Lever
 - Max Inlet Pressure 6 bar
 - Outlet Pressure of 28 mbar for LPG Use
 - Flow Rate of 1.5kgs/h
 - 20mm Inlet Size, 10mm Outlet Nozzle
- For LPG Use Only

PLPG-1001H

- Zinc Base & Aluminum Cover with POM Control Lever
 - Max Inlet Pressure 6 bar
 - Outlet Pressure of 28 mbar for LPG Use
 - Flow Rate of 1.5kgs/h
 - 20mm Inlet Size, 10mm Outlet Nozzle
 - With Hose
- For LPG Use Only

CARTRIDGE

PCG-1

- Capacity: 230g
 - Cylinder Gas for Portable Gas Cooker
 - Lasts Up to 3 Hours
- For Model: PPG-2002N

BLENDER ACCESSORIES

JC-4003

- 600ml • BPA Free Tritan Sports Bottle
 - Leak-proof Travel Lid and Snap Hook
- For Model: PB-4003B, PB-4004V, PB-4005P

JC-3203

- 1L
 - Stainless Steel Blade
- For Model: PB-3203, PB-3203L, PB-3205, PB-3205D, PB-3205L, PB-3206, PB-3301

MS-3310

- Stainless Steel Blade Cutter
 - Small Capacity Grinding
- For Model: PB-3203, PB-3203L, PB-3205, PB-3205D, PB-3205L, PB-3206, PB-3301

WATER HEATER
SHOWER HEAD
SH-01

- Rain Shower Head
- 5 Spray Pattern Handshower

For Model: PUH-910SR, PUH-911SR,
 PUH-910E, PUH-911E, PUH-911ER,
 PUH-968E, PUH-968EP,
 PUH-1000SPR, PUH-1001SPR

FAN BLADE

FB-12N

• 12"

FB-16N

• 16"

- A5 Fan Blade

DUCTING CAP

CHT-6001

- SUS304 Diameter 160mm Stainless Steel Wall Cap
- 3 Meter Aluminium Flexible Duct
- 1 Roll of Aluminium Foil Tap
- Easy To Install

For Model: PCH-801S, PCH-802S,
 PCH-803G, PCH-804G, PCH-806G, PCH-807S





SWIFT FREEZE

Concealed high efficiency compressor freezes items quickly and evenly to seal in freshness and nutrition.



ENERGY EFFICIENT

Durable, compact freezer runs on low energy consumption mode to save on utility bills and is kinder to the environment.



SAVE ON BULK

Stock pile perishables when there is a sale and plan healthy meals for your family, saving time, money and resources.

Energy efficient, space saver that helps you cut food costs.



CHILL & FREEZE

PFZ-152

CLEAN & FRESH CLOTHES ANYTIME!

5-YEARS
MOTOR WARRANTY
2-YEARS
PC BOARD WARRANTY

15.0
kg



Wash More, Save More!

15 kg capacity means wash more, less frequently, 6 energy efficient wash programmes and 8 water level control cuts down energy bills.



Extra Large? No worries

Large capacity allows washing of heavy and large blankets, curtains and even delicate items with ease.



Super Clean Dynamic Soak

Dynamic Soak loosens stubborn dirt with gentle agitator action before the actual washing cycle starts.



Smart Convenience

Select a program and set your washing to begin at a suitable time from 1 up to 24 hours later with 'Delay Start'.



WASHING MACHINE

**PWS-654A**

- 6.0kg
- Semi-auto
- Anti-pest Design (Rat)
- Plastic Body Free from Rust
- Spin Dryer Safety Functions:
 - Spinning Stops Automatically when Lid is Inadvertently Opened
- Water Inlet Selection
- Magic Cleaning Filter

**PWS-6002**

- 6.0kg
- Semi-auto
- Anti-pest Design (Rat)
- Plastic Body Free from Rust
- Elegant Glass Top
- Spin Dryer Safety Functions:
 - Spinning Stops Automatically when Lid is Inadvertently Opened
- Water Inlet Selection

**PWS-9002** • 9.0kg
PWS-1102 • 11.0kg

- Semi-auto
- Anti-pest Design (Rat)
- Plastic Body Free from Rust
- Spin Dryer Safety Functions:
 - Spinning Stops Automatically when Lid is Inadvertently Opened
- Water Inlet Selection

**PWS-6003** • 6.0kg
PWS-9003 • 9.0kg

- Semi-auto
- Anti-pest Design (Rat)
- Plastic Body Free from Rust
- Spin Dryer Safety Functions:
 - Spinning Stops Automatically when Lid is Inadvertently Opened
- Water Inlet Selection

**PWA-655A**

- 300W • 6.0kg
- Full Steel Body Free from Rust
- Stainless Steel Inner Tub
- LED Display • Dynamic Soak
- Error Code Alarm
- 5 Energy Saving Wash Programmes
- 8 Water Level Control
- 1-24 Hours Delay Start

**PWA-7351** • 330W • 7.3kg
PWA-8551 • 400W • 8.5kg

- Full Steel Body Free from Rust
- Stainless Steel Inner Tub
- LED Display • Dynamic Soak
- Error Code Alarm • Child Lock
- 6 Energy Saving Wash Programmes
- 8 Water Level Control
- 1-24 Hours Delay Start

**PWA-1551**

- 480W • 15.0kg
- Full Steel Body Free from Rust
- Stainless Steel Inner Tub
- LED Display • Dynamic Soak
- Error Code Alarm • Child Lock
- 6 Energy Saving Wash Programmes
- 8 Water Level Control
- 1-24 Hours Delay Start



PERFECT PILES WITH 3-IN-1 FUNCTION

Steam, Spray and Dry function, together with a comfortable handle and non-stick soleplate, turns piles of mess into perfectly pressed items.

VARIETY IS KING!

Adjustable temperature control and variable steam control ensures each type of fabric gets the attention it deserves during ironing for a flawless finish.

GOODBYE TO LIME SCALE

Self-cleaning feature conveniently cleans lime scale and impurities.

CREASE BANISHING, EFFORTLESS IRONING

PSI-1006





Amber Chia
Amber Chia
Pensonic Friend

amberchia
mesmerized by
PENSONIC



amberchia
powered by
PENSONIC

DC/AC Line
OVER-HEAT
PROTECTION
www.pensonic.com

HAIR in THE PINK

with IONIC TECHNOLOGY

The ionic function helps leave my hair silky smooth & frizz-free & it looks even healthier



2-SPEED 3 HEAT



COOL SHOT



IONIC
FUNCTION



AC MOTOR



EASY CLEANING



PHD-1100

Power : 1470-1600W
Voltage : 230-240V ~ 50/60Hz

• 2 Speeds

Optimal control for all hair types and textures

• Cool Shot Function

Set and style your hair with ease

• Small & Light Weight

Easy-carry and ideal for travelling

PHD-1101

Power : 1400W
Voltage : 220-240V ~ 50/60Hz

• 2 Speeds

Optimal control for all hair types and textures

• Cool Shot Function

Set and style your hair with ease and add shine

• Ionic Function

Protects hair from harmful static charge

• Small & Light Weight

Easily carried and ideal for traveling



PHD-2000P

Power : 1800W
Voltage : 220-240V ~ 50/60Hz

• 2 Speeds & 3 Heat Settings

Optimal control for all hair types and textures

• Cool Shot Function

Set and style your hair with ease and add shine

• Heat Balance Technology

Even heat distribution for efficient drying

• Complete Set of Accessories

Comes with nozzle, comb and diffuser to accommodate your different hairstyles

• Constant Temperature

Advanced fan technology delivers air streams for quick drying



PHD-2100

Power : 1800-2000W
Voltage : 230-240V ~ 50/60Hz

• 2 Speeds & 3 Heat Settings

Optimal control for all hair types and textures

• Cool Shot Function

Set and style your hair with ease and add shine

• Useful Hair Accessories

Slim nozzle and diffuser for wavy hair style

• Easy Cleaning

Detachable end cap for cleaning convenience

• Two Way Handling

Adjustable angle for optimal handling comfort

• Low Noise

Quiet operation eliminates irksome noise



PHD-2200P

Power : 2000-2200W
Voltage : 230-240V ~ 50/60Hz

• 2 Speeds & 3 Heat Settings

Optimal control for all hair types and textures

• Cool Shot Function

Set and style your hair with ease and add shine

• AC Motor

More durable and longer life span

• Easy Cleaning

Detachable end cap for cleaning convenience

• With Accessories

Ultra slim nozzle and diffuser for wavy hair style

• Ionic Function

Protect hair from harmful static charge



PHS-CS300

Power : 62W
Voltage : 220-240V ~ 50/60Hz

• PTC Heater

Constant heat for excellent hair protection

• Maximum Temperature 230°C

Heats up to 230°C for salon quality performance on the go

• Power ON Light Indicator

Shows the status of operation

• 360° Turnable Cord

Good handling and easy storage

• Barrel Locking

Switch between curler and straightener with just a single locking

• Ceramic Coating On Barrel

Reduce hair damage for soft and shiny hair



PHD-1001F

- 1000W • 2-Speed Selection
- Quiet Design • Foldable Handle
- Overheat Auto Shut Off Device
- Constant Temperature for Healthy Hair Care
- Heat Balance Technology
- Detachable Concentrator



PHD-2001

- 2000W • 2-Speed Selection
- 3 Heat Settings • Hang-up Hook
- Over-heat Auto Shut Off Device
- 'Cool Shot' to Freeze Style
- Removable Concentrator & Diffuser
- Removable Filter Cover for Easy Cleaning

CLASSIC

SERIES



01 JUG KETTLE
PAB-1707CS



02 BREAD MAKER
PBM-2001S



03 FOOD STEAMER
PSM-162S



04

GLASS JUG
KETTLE
PAB-1500CG



05

JUICER
PJ-6900S



06

SANDWICH
TOASTER
PST-9602S



SPECTACULAR,
TIMELESS, REFINED

Pensonic's Classic Series home appliances, defined by their understated elegance featuring cool, metallic exteriors with sleek lines and innovative features, perform as brilliantly as their good looks.

JUG KETTLE
PAB-1707CS

- Power: 1850-2200W
- Capacity: 1.7L
- 360° Rotational S/S Kettle
- With Concealed Heating Element
- Automatic Lid-opening Structure
- With Water Level Indicator
- Boil Dry Protection
- Automatic Switch Off
- Anti-slip Feet and Cord Storage

BREAD MAKER
PBM-2001S

- Power: 710W
- 15 Preset Programmes
- 3 Loaf Size Selection (1.0LB, 1.5LB, 2.0LB)
- 3 Adjustable Crust Settings (Light, Medium, Dark)
- 15 Minutes Power Interruption Backup System
- 15-hour Programmable Delay-start Timer
- Removable Non-stick Bowl for Easy Cleanup
- Accessories: Measuring Cup, Measuring Spoon, Hook

FOOD STEAMER
PSM-162S

- Power: 800W
- Capacity: 1.2L
- Stainless Steel Housing
- 60 Minute Timer with Auto Shut Off & Chime
- Water Window with Side Water Refill Facility
- Indicator Light
- 1.0L Rice Bowl
- 2 Big Capacity Steamer Container

GLASS JUG KETTLE
PAB-1500CG

- Power: 1850-2200W
- Capacity: 1.5L
- German Schott Glass
- Safety Auto Shut Off and Boil Dry Protection
- Ergonomic Handle with Lid Release Button
- Soft Opening Lid Prevents Splashing
- On/Off Switch with Indicator Light

JUICER
PJ-6900S

- Power: 600W
- Capacity: 1.5L Pulp Container
750ml Juice Cup
- 75mm Diameter Feeding Tube Available for Juicing
- Stainless Steel Housing and Blade Assembly
- Stainless Steel Filter Basket for Easy Cleaning
- Two Speed Control Section
- Overheat Protector on Powerful Motor
- Safety Lock Device
- Unique Detachable Parts for Easy Cleaning and Placement
- Accessories: Cleaning Brush

SANDWICH TOASTER
PST-9602S

- Power: 700-800W
- Cool Touch Housing
- Non-stick Coating
- Durable Casing
- Skid-resistant Feet
- Cord Storage
- Built-in Indicator Light

01

TABLE FAN
PF-31S

- 45W
- 12" (300mm)
- 4 Wider Metal Blades
- 3-Speed Rotary Control
- Heavy Base for Stability
- Wide Angle Automatic Swing
- Spider Fan Guard

02

STAND FAN
PSF-46S

- 60W
- 16" (400mm)
- Height Adjustment
- 4 Wider Metal Blades
- 3-Speed Rotary Control
- Heavy Base for Stability
- Wide Angle Automatic Swing
- Spider Fan Guard

03

04

05

06

07

08



07
TABLE FAN
PF-31S

08
STAND FAN
PSF-46S

PENSONIC SALES & SERVICE CENTRES (MALAYSIA)

PENANG HEAD OFFICE & SHOWROOM

1165, Lorong Perindustrian Bukit Minyak 16,
Taman Perindustrian Bukit Minyak,
14100 Simpang Ampat, PENANG, Malaysia.
Tel.Fax (604) 5070 393 / 5073 825

PENANG

143-145, Perak Rd. , 10150 PENANG

JOHOR BAHRU

31, Jln Ros Merah Satu / 1,
Tmn Johor Jaya, 81100 J. Bahru, JOHOR

KOTA BHARU

PT-621, Ground Floor, Batu 2 Jln Pengkalan
Chepa, 15400 Kota Bharu, KELANTAN

KUANTAN

No. A143, Ground Floor, Jln Wong Ah Jang,
25100 Kuantan, PAHANG

KUALA LUMPUR SHOWROOM & CUSTOMER CARE CENTRE

Lot 11B, Jln 223 Sec 51A,
46100 Petaling Jaya,
SELANGOR DARUL EHSAN
Showroom
Tel.Fax (603) 7954 5200 / 7954 5705
Customer Care Centre
Tel.Fax (603) 7954 5221 / 7954 5706

IPOH

29, Jalan Medan Ipoh 1A,
Medan Ipoh Bistari, 31400 Ipoh, Perak.

MALACCA

385-C, Jalan Melor Utama,
Taman Perlinggit Jaya,
75400 MALACCA

SABAH

Lot 4, Ground Floor,
Towering Industrial Centre,
88300 Penampang, K. Kinabalu, SABAH

SARAWAK

JRD & 1st Floor, Lot 328,
No. 46, Lorong 7B, Jalan Ang Cheng Ho,
93100, Kuching, SARAWAK.

LABUAN

Lot 7-8, Wisma Wong Wo Lo
Batu Arang, P.O. Box 82182 W.P Labuan
Tel. Fax: (6-087) 426977 / 425977

Lot 5-6, Wisma Wong Wo Lo
Batu Arang, P.O. Box 82182 W.P Labuan
Tel. Fax: (6-087) 423977 / 424977



Please Call

1-800-881-770

call this number for any enquiries

For Prompt After-Sales Service (For Malaysia Only)

* Operation Hours: Mon - Fri 8:30am - 5:45pm / Sat, Sun & Public Holiday Closed

PENSONIC SALES & SERVICE CENTRES (WORLD WIDE)

CHINA

5F, Block 16, Xiang Zhou Technology Industrial
District, No 2372 Meihua Xi Road, Xiangzhou,
Zhuhai City, 519075 China
Tel.Fax (0756) 8525 922/933 / 2655 271

INDONESIA

Kompleks Ruko Glodok Plaza,
Blok F No. 111 - 112, Jl Pinangsi Raya,
Jakarta Barat 11110, Indonesia
Tel. (62) 21 6016 880 Fax. (62) 21 6492 596

VIETNAM

No 59-61 Nguyen Thi Thap Street,
Him Lam Area, Tan Phong Ward, District 7
Ho Chi Minh City, Vietnam
Tel.Fax (848) 3945 3483 / 3945 3482

YEMEN

Talz Street Sana'a Republic Of Yemen
Tel.Fax (9671) 609 798 / 444 752

EQUATORIALE GUINEA

Calle Ebebeyin
B. P: 177, Malabo, Equitoriale Guinea
Tel.Fax (204) 096 444

BAHRAIN

P. O. Box 10887,
Manama, Bahrain
Tel.Fax (973) 1722 4220 / 1770 0043

TIMOR LESTE

RuaBidau Lecidere,
PO Box 039,
Dill, Timor Leste
Tel. (670) 331 1278

HONG KONG

Suite 1404, Tung Wai Commercial Building
109-111 Gloucester Road,
Wan Chai, Hong Kong
Tel.Fax (852) 2727 0997 / 2758 5088

BRUNEI

No. D1, Spg 396, Jln Jerudong,
Bangunan Perkasa 1, Kampung Sengkurong B,
Bq 1321, Brunei Darussalam
Tel.Fax (673) 2611 918 / 2610 801

CAMBODIA

No. 143 EOE1E2, Street NW21,
Bayab Village, Sangkat Phnom Penh Thmey,
Sen Sok District,
Phnom Penh, Kingdom of Cambodia
Tel.Fax (855) 89 308 474

LEBANON

Verdun-Bekaa Str-Zahraa, Bldg-3 Fir,
P. O. Box 155150 Beirut-Lebanon
Tel.Fax (961) 1817 681 / 1318 152

SRI LANKA

No. 21, Siebel Avenue,
Colombo 05, Sri Lanka
Tel. (9411) 2593 763 Fax. (9411) 2806 509

SEYCHELLES

P.O.Box 1371, Victoria Mahe,
Seychelles
Tel.Fax (248) 323 680 / 324 724

PAKISTAN

Shop # 40 & 45, Gemini Shopping Plaza,
Opp BVS School, Abdullah Haroon Road Saddar,
Karachi-74400
Tel.Fax (9221) 3271 1377

SINGAPORE

2 Leng Kee Road, #06-03 Thye Hong Centre,
Singapore 159086
Tel.Fax (65) 6472 6504 / 6475 9534

THAILAND

83/ 161-162 Moo 6, Soi Chinaket 2,
Ngamwongwan Rd. , Thungsonghong, Laksi,
Bangkok 10210, Thailand
Tel.Fax (622) 9545 281-3 / 5807 443

PHILIPPINES

Unit 1, 131 Olympia Bldg. , Quirino Highway,
Baesa, Quezon City, Manila, Philippines, 1115
Tel.Fax (632) 334 1212

606 Evangelista St. Quiapo Manila
Tel. 7357690 / 7332851

EGYPT

Usama Shahin St of Saad Zaglot St. , El Bar
Elsharkey Shihin El Kom Menofia
POB 32514 Egypt
Tel.Fax (201) 0009 3033

FIJI

Centerpoint 1, Ratu Dovi Road
GPO Box 14416 Suva Fiji
Tel.Fax (679) 339 3111 / 334 0255

IRAQ

Karradah Al Masbah
Baghdad, Iraq
Tel. (964) 770 533 1123

